

# **FURUNO**

## **OPERATOR'S MANUAL**

*MULTI BEAM SONAR*

Model

**DFF-3D**

---

**ECF**

(Elemental Chlorine Free)

The paper used in this manual  
is elemental chlorine free.

**FURUNO ELECTRIC CO., LTD.**

9-52 Ashihara-cho,  
Nishinomiya, 662-8580, JAPAN

• FURUNO Authorized Distributor/Dealer

All rights reserved. Printed in Japan

Pub. No. OME-13520-D2

(ETMI ) DFF-3D

A : DEC. 2016

D2 : AUG. 07, 2018



0 0 0 1 9 1 4 2 9 1 3

# IMPORTANT NOTICES

---

## General

- This manual has been authored with simplified grammar, to meet the needs of international users.
- The operator of this equipment must read and follow the descriptions in this manual. Wrong operation or maintenance can cancel the warranty or cause injury.
- Do not copy any part of this manual without written permission from FURUNO.
- If this manual is lost or worn, contact your dealer about replacement.
- The contents of this manual and equipment specifications can change without notice.
- The example screens (or illustrations) shown in this manual can be different from the screens you see on your display. The screens you see depend on your system configuration and equipment settings.
- Save this manual for future reference.
- Any modification of the equipment (including software) by persons not authorized by FURUNO will cancel the warranty.
- The following concern acts as our importer in Europe, as defined in DECISION No 768/2008/EC.
  - Name: FURUNO EUROPE B.V.
  - Address: Ridderhaven 19B, 2984 BT Ridderkerk, The Netherlands
- All brand and product names are trademarks, registered trademarks or service marks of their respective holders.

## How to discard this product

Discard this product according to local regulations for the disposal of industrial waste. For disposal in the USA, see the homepage of the Electronics Industries Alliance (<http://www.eiae.org/>) for the correct method of disposal

## How to discard a used battery

Some FURUNO products have a battery(ies). To see if your product has a battery, see the chapter on Maintenance. Follow the instructions below if a battery is used. Tape the + and - terminals of battery before disposal to prevent fire, heat generation caused by short circuit.

### In the European Union

The crossed-out trash can symbol indicates that all types of batteries must not be discarded in standard trash, or at a trash site. Take the used batteries to a battery collection site according to your national legislation and the Batteries Directive 2006/66/EU.

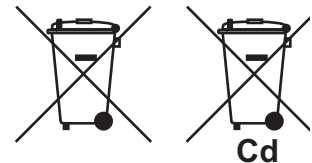

### In the USA

The Mobius loop symbol (three chasing arrows) indicates that Ni-Cd and lead-acid rechargeable batteries must be recycled. Take the used batteries to a battery collection site according to local laws.

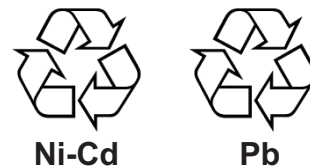



### In the other countries

There are no international standards for the battery recycle symbol. The number of symbols can increase when the other countries make their own recycle symbols in the future.









# SAFETY INSTRUCTIONS





The installer and user must read the applicable safety instructions before attempting to install or operate the equipment.

 <b>WARNING</b>	Indicates a potentially hazardous situation which, if not avoided, could result in death or serious injury.
 <b>CAUTION</b>	Indicates a potentially hazardous situation which, if not avoided, may result in minor or moderate injury.





 Warning, Caution	 Prohibitive Action	 Mandatory Action
--	--	--





## Safety instructions for the operator

 <b>WARNING</b>	
	<b>Do not open the equipment.</b> Only qualified personnel can work inside the equipment.
	<b>Do not disassemble or modify the equipment.</b> Fire, electrical shock or serious injury can result.
	<b>Turn off the power immediately if the equipment is emitting smoke or fire.</b> Fire or electrical shock can result if the power is left on.
	<b>Turn off the power immediately if water leaks into the equipment or an object is dropped inside the equipment.</b> Continued use can cause fire or electrical shock.
	<b>Turn off the power immediately if you feel the equipment is acting abnormally.</b> If the equipment is hot to the touch or is emitting strange noises, turn off the power immediately and contact your dealer for advice.

 <b>WARNING</b>	
	<b>Do not operate the equipment with wet hands.</b> Electrical shock can result.
	<b>Do not place liquid-filled containers on the top of the equipment.</b> Electrical shock can result.
	<b>Use the proper fuse.</b> Use of a wrong fuse can damage the equipment and may cause fire.

**Safety instructions for the installer**

 <b>WARNING</b>	
	<p><b>Do not work inside the equipment unless qualified to do so.</b></p> <p>Electrical shock can occur.</p>
	<p><b>Turn off the power before beginning the installation.</b></p> <p>Fire or electrical shock can result if the power is on.</p>
	<p><b>Be sure no water leaks at the mounting location for the transducer.</b></p> <p>Water leakage can sink the vessel. Also, confirm that the transducer will not loosen by vibration. The installer is solely responsible for the installation.</p>
	<p><b>Confirm that the power supply voltage is within the rating of this equipment.</b></p> <p>Incorrect voltage will damage the equipment and may cause fire.</p>

 <b>CAUTION</b>	
	<p><b>The transducer cable must be handled carefully, following the guidelines below.</b></p> <ul style="list-style-type: none"> <li>• Keep fuels and oils away from the cable.</li> <li>• Locate the cable away from chemicals.</li> <li>• Locate the cable away from locations where it might be damaged.</li> </ul>
	<p><b>Do not disconnect the motion sensor while the sonar is powered.</b></p> <p>The sensor may be damaged.</p>
	<p><b>Do not apply the power with the transducer exposed to air.</b></p> <p>The transducer may be damaged.</p>
	<p><b>A magnetic compass may receive interference if it is placed too close to this unit. Observe the compass safe distances shown below to prevent interference to a magnetic compass.</b></p> <p>Standard compass: 1.25 m Steering compass: 0.80 m</p>

# TABLE OF CONTENTS

---

<b>FOREWORD</b> .....	<b>vi</b>
<b>SYSTEM CONFIGURATION</b> .....	<b>vii</b>
<b>1. INSTALLATION</b> .....	<b>1-1</b>
1.1 Equipment Lists.....	1-1
1.2 How to Install the Sonar .....	1-2
1.3 Transducer .....	1-3
<b>2. WIRING</b> .....	<b>2-1</b>
2.1 Ground .....	2-1
2.2 Transducer Cable.....	2-2
2.3 External KP Cable.....	2-5
2.4 LAN Cable.....	2-9
<b>3. INITIAL SETTINGS</b> .....	<b>3-1</b>
3.1 DIP Switch Setting .....	3-1
3.2 Operation Check .....	3-3
3.3 Multi Function Display Initial Settings.....	3-4
<b>4. OPERATION</b> .....	<b>4-1</b>
4.1 Display Screens Overview .....	4-1
4.2 Multi-Sounder Display Operations .....	4-4
4.2.1 How to switch between TX and STBY .....	4-4
4.2.2 How to switch between single beam and triple beam presentations.....	4-4
4.2.3 How to set the TX beam angle.....	4-4
4.2.4 How to set the TX beam width .....	4-4
4.2.5 How to show or hide the scale box .....	4-4
4.2.6 Availability of points and event marks registration, and go to a point .....	4-5
4.3 Side Scan Display Operations .....	4-6
4.3.1 How to switch between TX and STBY .....	4-6
4.3.2 How to change echo color.....	4-6
4.3.3 How to show or hide the scale box .....	4-6
4.3.4 Availability of points and event marks registration, and go to a point .....	4-7
4.4 Cross Section Display Operations .....	4-8
4.4.1 How to switch between TX and STBY .....	4-8
4.4.2 How to show or hide the grid.....	4-8
4.4.3 Zoom display.....	4-8
4.4.4 How to smooth echoes (distance).....	4-8
4.4.5 How to smooth echoes (time) .....	4-9
4.4.6 How to apply correction to the speed of sound.....	4-9
4.4.7 How to show or hide the scale box .....	4-9
4.4.8 Availability of points and event marks registration, and go to a point .....	4-10
4.5 3D Sounder History Display Operations .....	4-11
4.5.1 How to switch between TX and STBY .....	4-11
4.5.2 How to move, zoom in, zoom out the viewpoint position .....	4-11
4.5.3 How to mark school of fish.....	4-11
4.5.4 How to stop advancement of the display .....	4-12
4.5.5 How to adjust the echo detection level.....	4-12
4.5.6 How to calibrate the seabed echo.....	4-12
4.5.7 How to use the noise filter.....	4-12
4.5.8 How to use terrain shading .....	4-13
4.5.9 Depth/Color Shading display.....	4-13

4.5.10 How to show or hide the scale box.....4-16

4.5.11 Availability of points and event marks registration, and go to a point.....4-17

**5. MAINTENANCE, TROUBLESHOOTING .....5-1**

5.1 Maintenance .....5-1

5.2 How to Replace the Fuse .....5-2

5.3 How to Restore Default Settings .....5-2

**APPENDIX 1 MENU TREE .....AP-1**

**APPENDIX 2 JIS CABLE GUIDE .....AP-3**

**APPENDIX 3 INSTALLATION OF TRANSDUCER B54, SS54 .....AP-4**

**APPENDIX 4 INSTALLATION OF TRANSDUCER TM54.....AP-10**

**SPECIFICATIONS ..... SP-1**

**PACKING LISTS ..... A-1**

**OUTLINE DRAWING ..... D-1**

**INTERCONNECTION DIAGRAM ..... S-1**

**INDEX ..... IN-1**

# FOREWORD

---

## A Word to the Owner of the DFF-3D

Congratulations on your choice of the FURUNO DFF-3D Multi Beam Sonar. We are confident you will see why the FURUNO name has become synonymous with quality and reliability.

Since 1948, FURUNO Electric Company has enjoyed an enviable reputation for quality marine electronics equipment. This dedication to excellence is furthered by our extensive global network of agents and dealers.

This equipment is designed and constructed to meet the rigorous demands of the marine environment. However, no machine can perform its intended function unless installed, operated and maintained properly. Please carefully read and follow the recommended procedures for installation, operation and maintenance.

Thank you for considering and purchasing FURUNO.

## Features

The DFF-3D Multi Beam Sonar provides high definition images of underwater conditions and the seabed. Connected to the NavNet TZtouch/NavNet TZtouch2 Multi Function Display, the DFF-3D distributes images of the undersea throughout the NavNet network, via LAN.

The main features of the DFF-3D are as follows.

- TX beam detects undersea conditions 120° in port and starboard directions.
- The motion sensor, provided standard, stabilizes the display to give clear and stable images even under rough sea conditions.

## CE declaration

With regards to CE declarations, please refer to our website ([www.furuno.com](http://www.furuno.com)) for further information about RoHS conformity declarations.



# SYSTEM CONFIGURATION

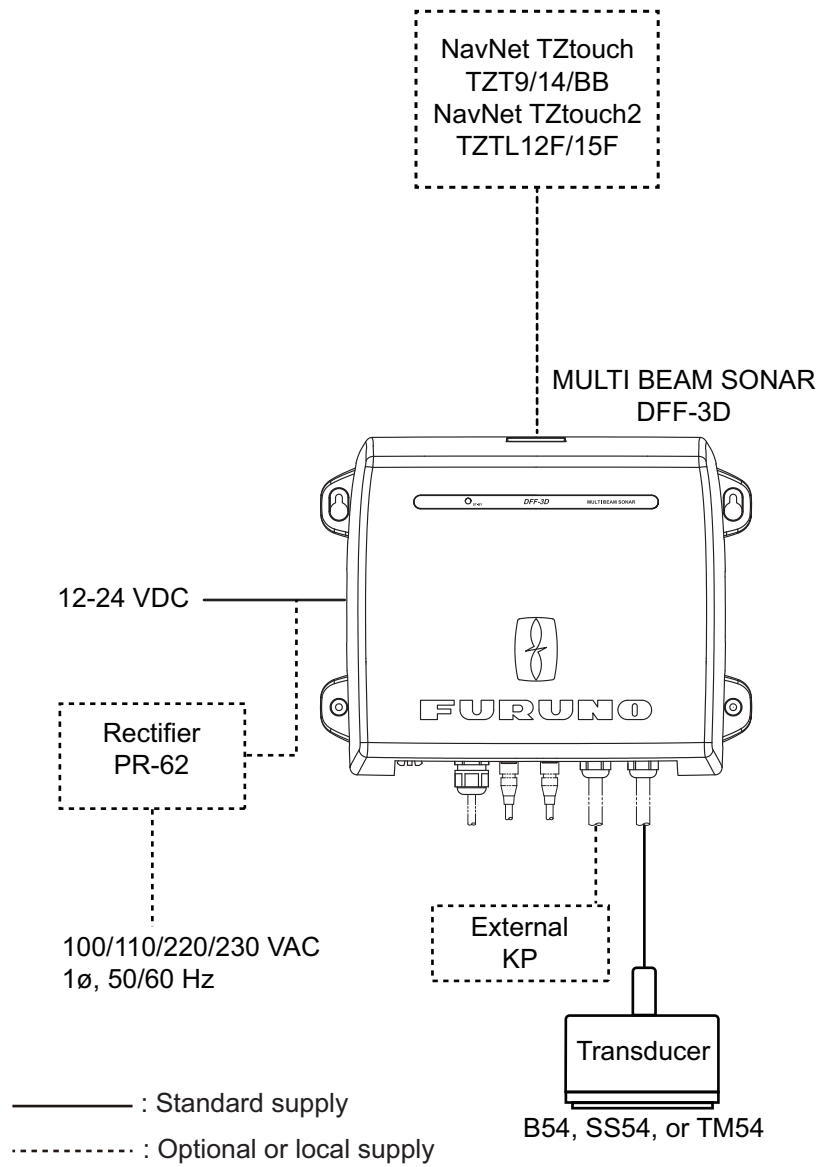

This page is intentionally left blank.

# 1. INSTALLATION

## 1.1 Equipment Lists

### Standard supply

Name	Type	Code No.	Qty	Remarks
Multi Beam Sonar	DFF-3D	-	1	
Transducer	B54	-	1	Select one. B54: Thru-hull mount (bronze) SS54: Thru-hull mount (stainless steel) TM54: Transom mount
	SS54	-		
	TM54	-		
Spare Parts	SP02-05601	001-033-740	1 set	Fuses
Installation Materials	CP02-09400	000-029-992	1 set	<ul style="list-style-type: none"> <li>• Power cable assy. (3.5 m)</li> <li>• LAN cable assy. (5 m)</li> <li>• Self-tapping screws</li> <li>• Conductive tape</li> </ul>

### Optional supply

Name	Type	Code No.	Remarks
Connector Kit for TX Sync	OP02-86	001-205-780	
Cable Assembly	MOD-Z072-020+	001-167-880-10	2 m, for HUB-101
Cable Assembly	MOD-Z072-100+	001-167-900-10	10 m, for HUB-101
Rectifier	PR-62	000-013-484	100 VAC
		000-013-485	110 VAC
		000-013-486	220 VAC
		000-013-487	230 VAC

## 1.2 How to Install the Sonar

This sonar can be installed on a deck or on a bulkhead. When selecting a mounting location, keep the following points in mind:

- Install the unit indoors.
- The operating temperature range of this unit is  $-15^{\circ}\text{C}$  to  $55^{\circ}\text{C}$  ( $5^{\circ}\text{F}$  to  $131^{\circ}\text{F}$ ). Be sure the mounting location satisfies this requirement.
- Locate the unit away from exhaust pipes and vents.
- The mounting location should be well ventilated.
- Mount the unit where shock and vibration are minimal.
- Keep the unit away from electromagnetic field-generating equipment such as motors and generators.
- Observe the minimum recommended maintenance space shown in the outline drawing at the back of this manual. Also, leave slack in cables for maintenance and servicing ease.
- A magnetic compass may receive interference if it is placed too close to this unit. Observe the compass safe distances noted in the safety instructions to prevent interference to the magnetic compass.
- For mounting on a bulkhead, the connectors must face downward.

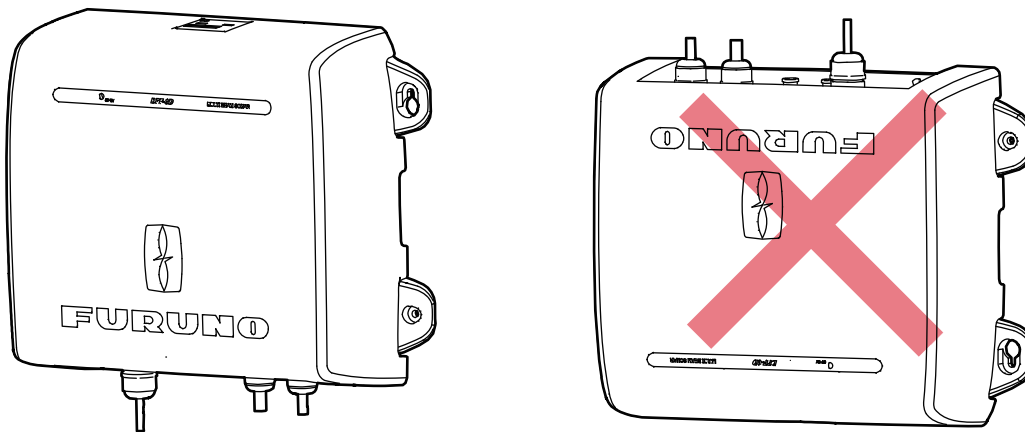

Fasten the unit to the mounting location with four self-tapping screws (5×20, supplied), referring to the outline drawing at the back of this manual for mounting dimensions.

## 1.3 Transducer

### Thru-hull mount

The installation position of the transducer directly affects the performance of the transducer. For best performance, keep the following points in mind when selecting the mounting location.

- Select a location where the influence of water flow and air bubbles is minimal.
- Select a place least influenced by engine noise.
- Do not install the transducer inboard.
- For FRP vessel, do not cover the transducer with fiberglass, to prevent damage to the transducer if the temperature rises.
- Bottom slope angle less than 24°

The illustration below is the transducer with fairing, and was created by the Airmar® Technology Corporation. The BOW mark (arrow) on the fairing and the triangular recess should be facing the bow.

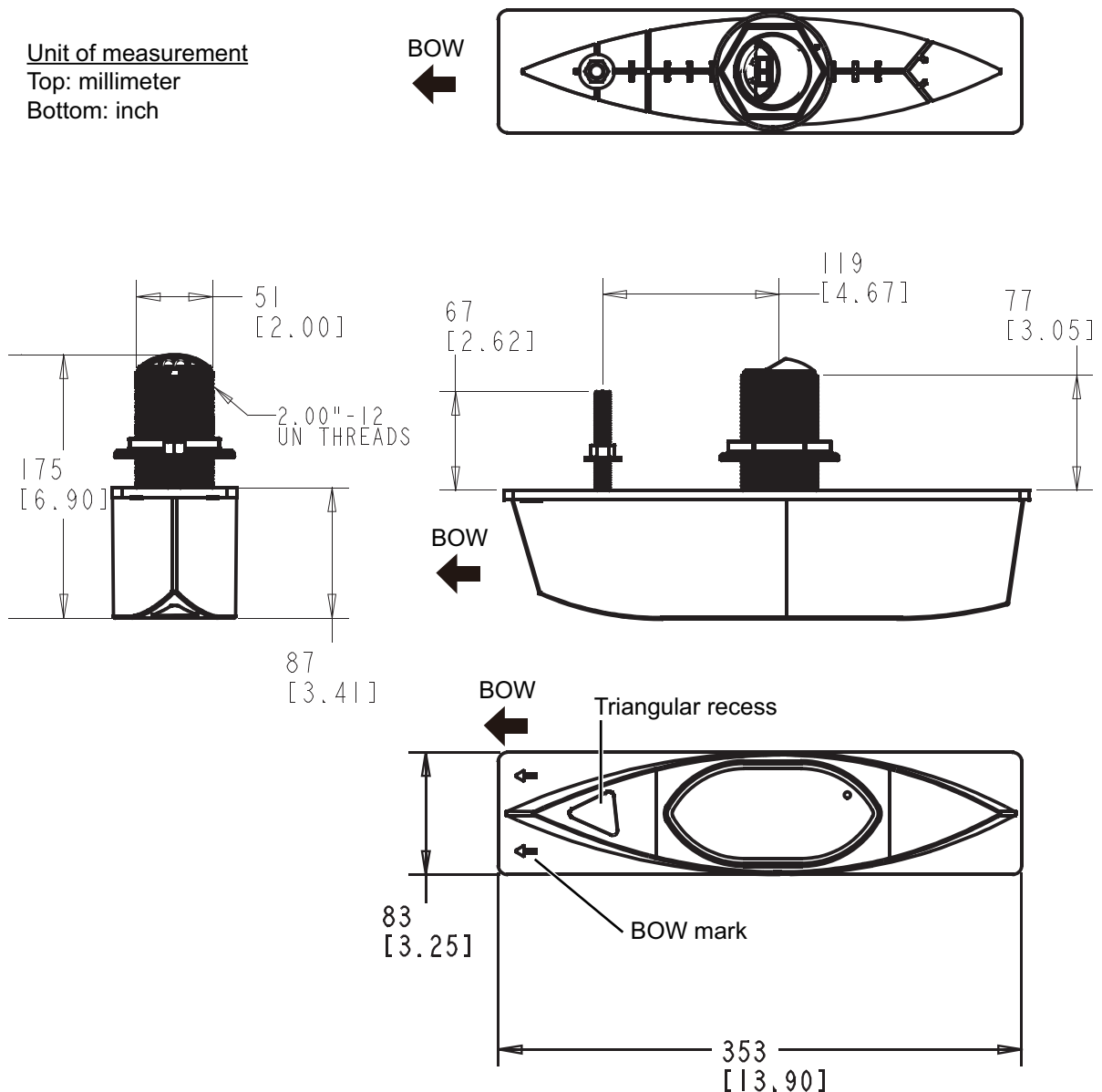

# 1. INSTALLATION

Unit of measurement  
Top: millimeter  
Bottom: inch

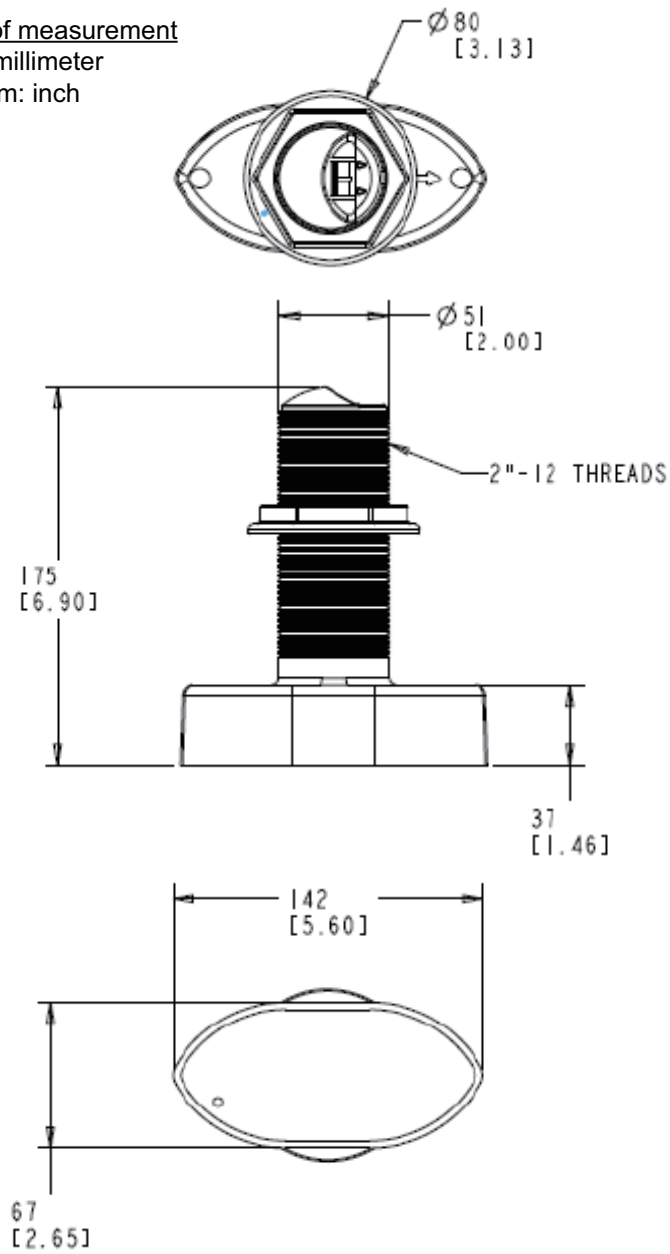

**Transom mount**

For a vessel with an inboard engine, the transducer cannot be installed aft of the propeller screw because of the turbulence created by the propeller ahead of the transducer. Determine the mounting location considering the guidelines shown below and the instructions on page AP-8.

- Select a location as far as possible from the propeller screw.
- Select a location where the propeller screw is not within 120° of the beam range of the transducer.

Be sure to select the location considering these guidelines, to prevent echo noise on the display.

The illustration below was created by the Airmar® Technology Corporation.

**Unit of measurement**

Top: millimeter

Bottom: inch

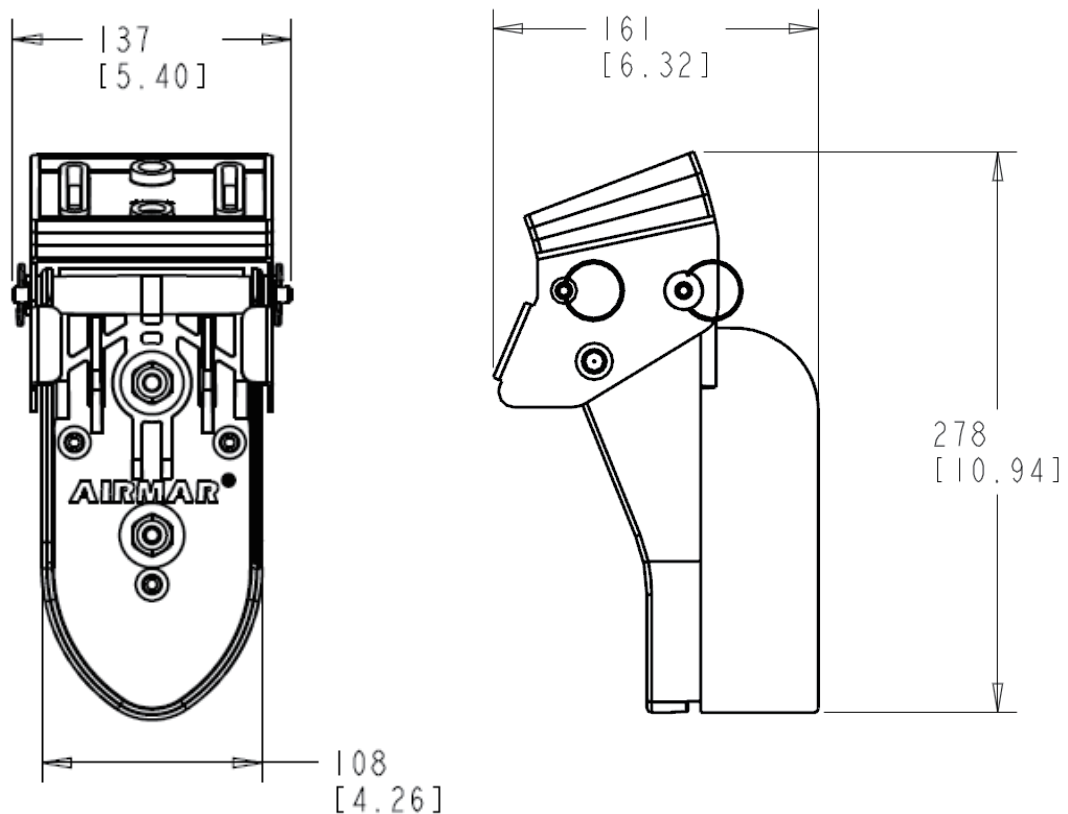

## 1. INSTALLATION

This page is intentionally left blank.



## 2. WIRING

Connect the power cable and transducer cable as shown below. See the next page for how to fabricate the transducer cable.

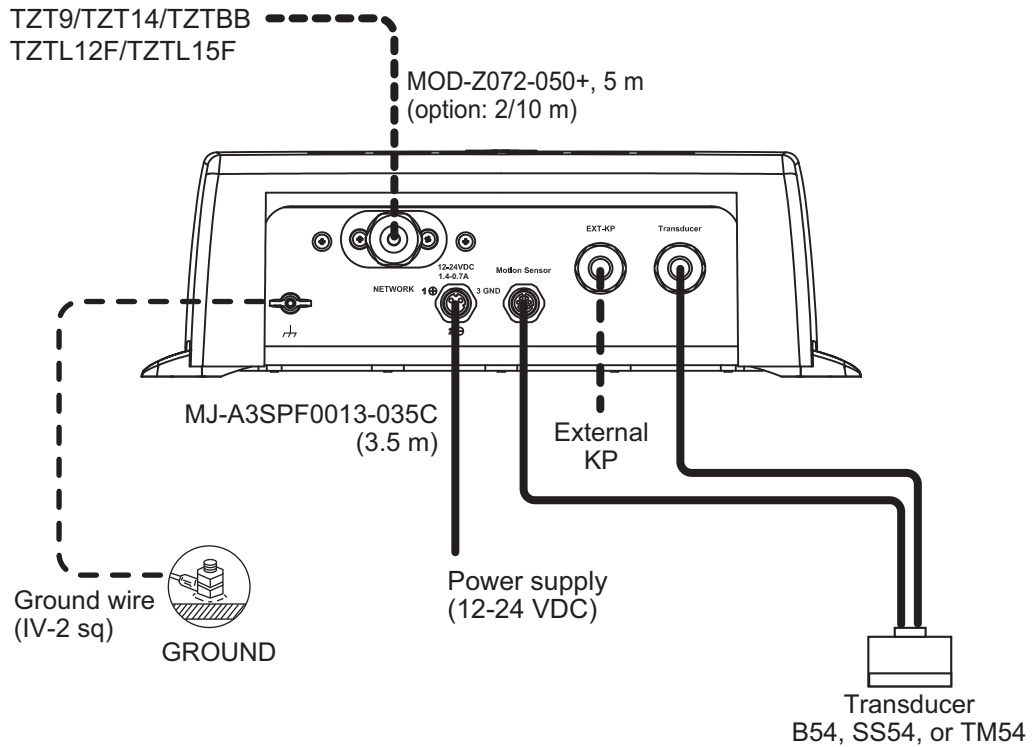

### 2.1 Ground

Connect a ground wire (1V-2 sq, local supply) between the ground terminal and ship's ground to prevent interference to the sounder picture. Make the length of the wire as short as possible. For FRP vessels, install a ground plate (approx. 20 cm by 30 cm) on the outside of the hull bottom and connect the ground wire there.

## 2.2 Transducer Cable

Separate the transducer cable as far as possible from power cables to prevent interference to the sonar. Keep the transducer cable away from televisions and monitors to prevent noise in the cable.

Fabricate the cable as shown in the procedure below, then connect it inside the unit with a WAGO connector.

1. Fabricate the cable as shown below.

**Note:** Keep the recommended lengths to prevent noise in the cable.

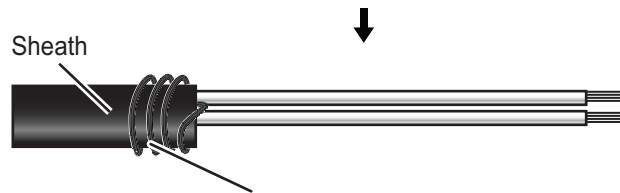
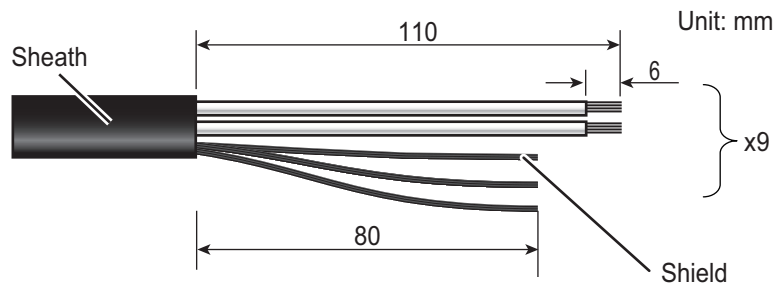

The cable has one or three shield cores. Wrap the shield(s) around the sheath.

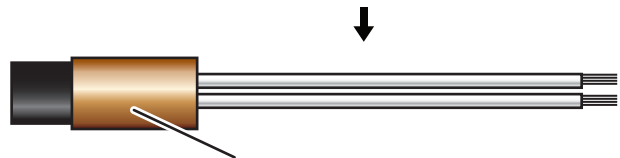

Wrap shield with conductive tape.

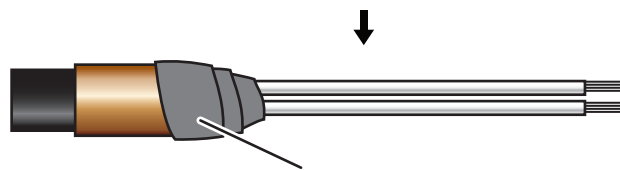

Wrap with vinyl tape (width: 30 mm).

2. Remove the outer cover.
3. Unfasten four screws to remove the inner chassis cover.

4. Detach three WAGO connectors, TB1, TB2, TB3.

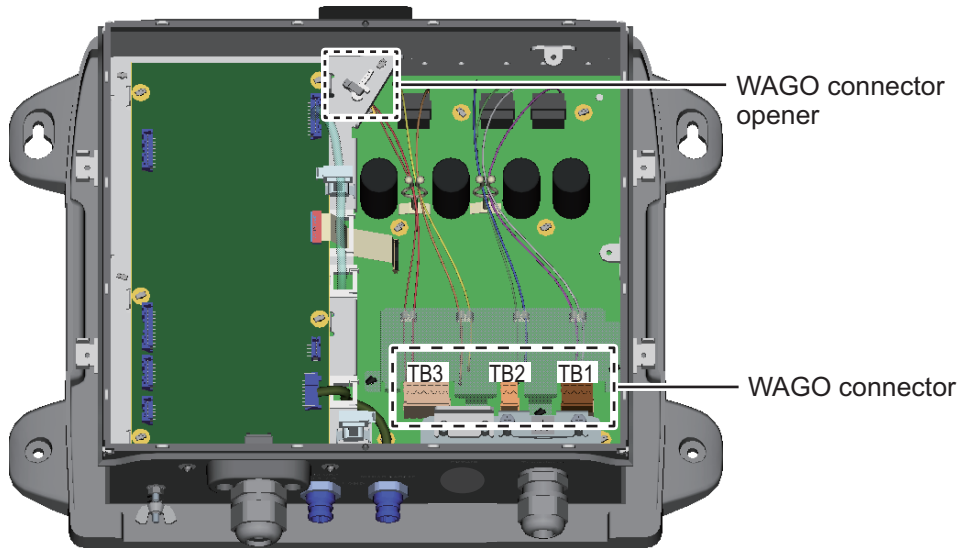

5. Unfasten the sealing nut from the super gland for the transducer cable.

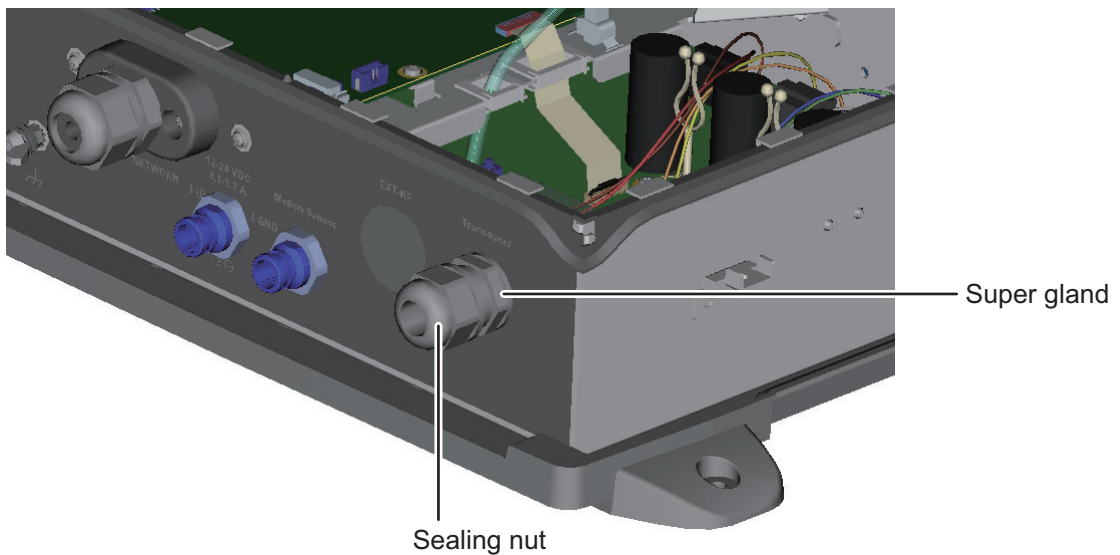

6. Unfasten two screws to remove the clamping plate for the transducer cable.

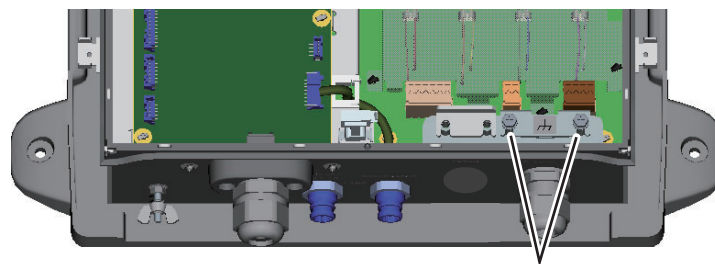

Unfasten these screws to remove the clamping plate.

7. Pass the transducer cable through the sealing nut (unfastened at step 5), then pass the cable through the super gland and into the unit.

## 2. WIRING

- Referring to the interconnection diagram (at the back of this manual) and the illustration below, connect the transducer cable to WAGO connectors. (The WAGO connector opener is provided inside the unit. See the figure at step 4 for the location.)

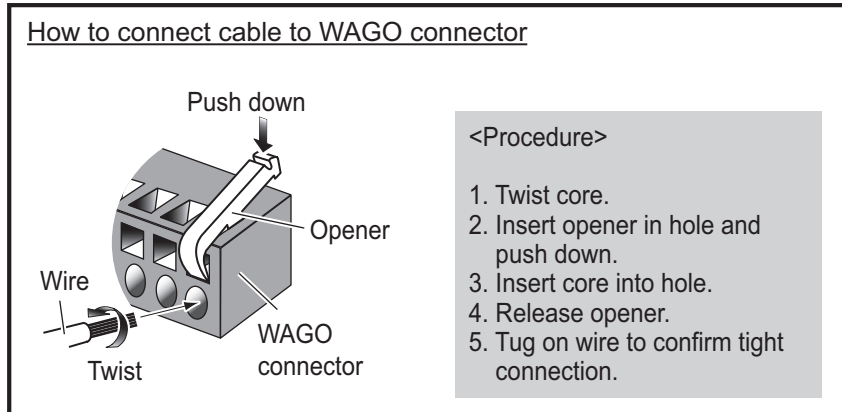

- Reattach the WAGO connectors.
- Set the cable where the clamping plate was removed (at step 6). As shown in the figure below, lay the cable such that its conductive tape lies beneath the clamping plate. Hold the clamping plate in place with your fingers then fasten the plate.

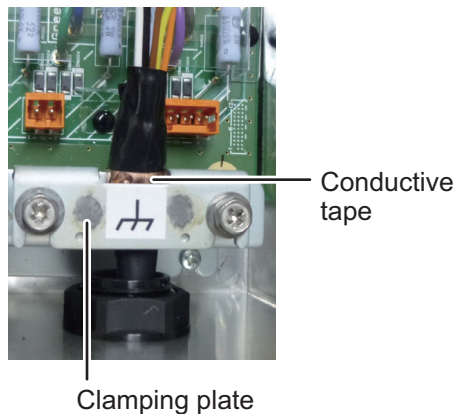

- Fasten the sealing nut into the super gland. The gap between the sealing nut end and the super gland should be 2 mm. The fastening torque is 1.8 - 2.0 N•m.



- Reattach the inner and outer covers.

## 2.3 External KP Cable

The Connector Kit for TX Sync (see the table below) and the cable MPYC(SLA)-4 are required to connect external KP.

### Contents of Connector kit for TX sync

Name	Type	Code No.	Qty	Remarks
Upset UI Screw-B	M4×20	000-163-756-10	2	
Super Gland	MGB20M-12B	000-177-248-10	1	
PH Connector Assembly	02-1097 (4P)	001-206-000	1	
Cable Clamping Plate	02-167-1528	100-379-090-10	1	
Rainproof Panel	02-167-1529	100-379-100-10	1	No use. May be discarded.
EMI Core	GRFC-10	000-177-010-10	1	
Crimp-on Lug	NCW-1.25	000-157-213-10	4	

**Note:** FURUNO recommends use of the JIS cable MPYC(SLA)-4 (or equivalent, see Appendix 1). However, if the wiring environment is such that the cable may contact seawater, use a cable whose armor is covered with a vinyl sheath to prevent corrosion.

1. Fabricate the cable for the external KP as shown below.
  - a) Make the length of the wires of the PH connector assembly (supplied) 100 mm.
  - b) Remove the sheath from the cores 10 mm.
  - c) Fold back the cores in half. Attach crimp-on lug NCW-1.25 (supplied) to each core.

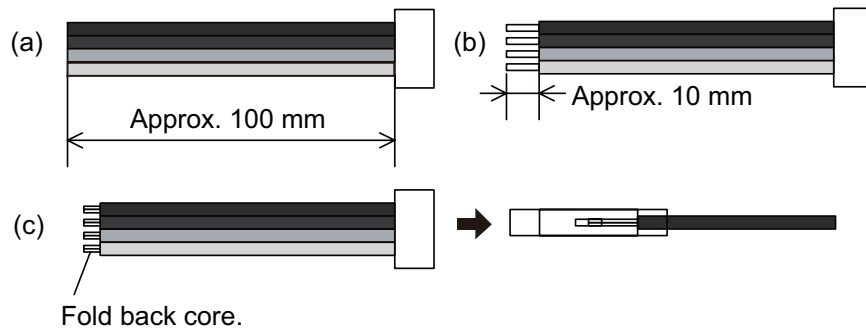

- d) Remove the armor 300 mm and cut off the vinyl sheath 130 mm

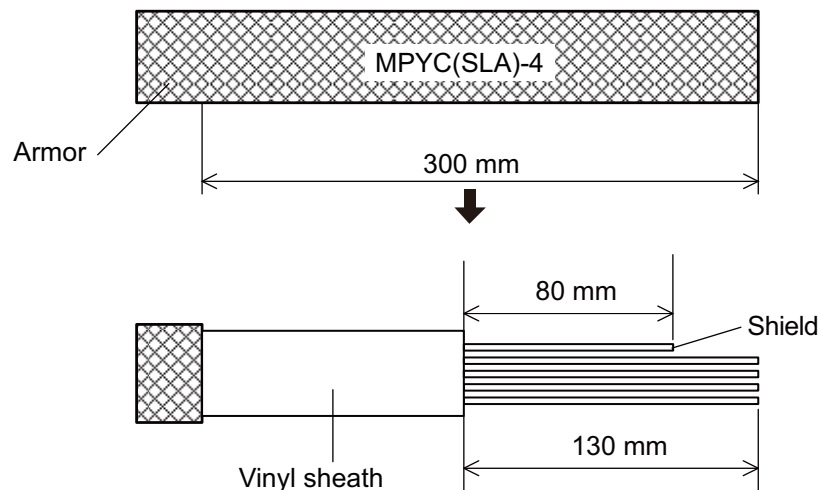

## 2. WIRING

- e) Remove 5 mm of the vinyl sheath from the cores then connect a crimp-on lug to each core as shown below.

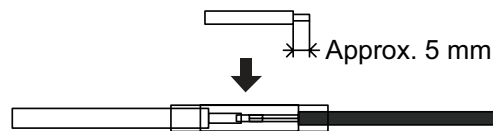

- f) Attach supplied crimp-on lug (FV1.25-4(LF) RED)) to the shield.
- g) Referring to the illustration below, wrap the armor with vinyl tape at the locations shown. Pass the cable through its cable gland. Fix the cable with the cable clamp and sealing nut.

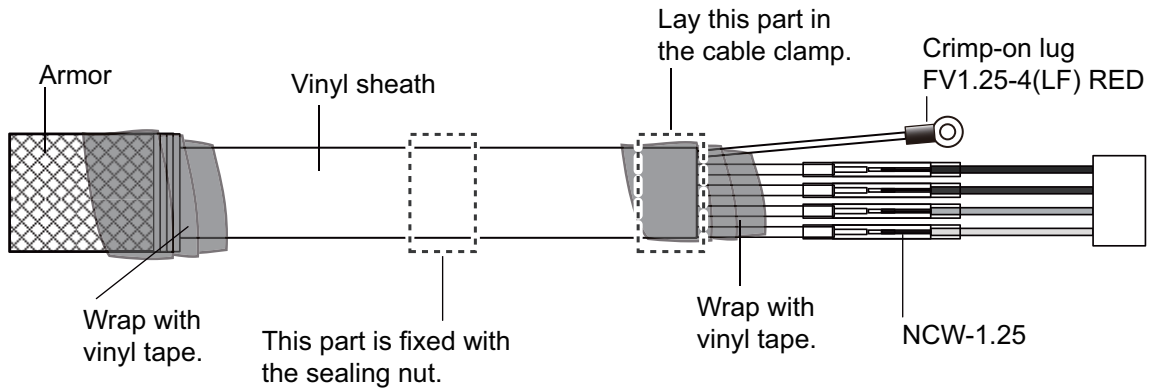

2. Remove the outer cover.
3. Loosen four screws to remove the inner chassis cover.
4. Detach the protective sheet from the location for the external KP cable.

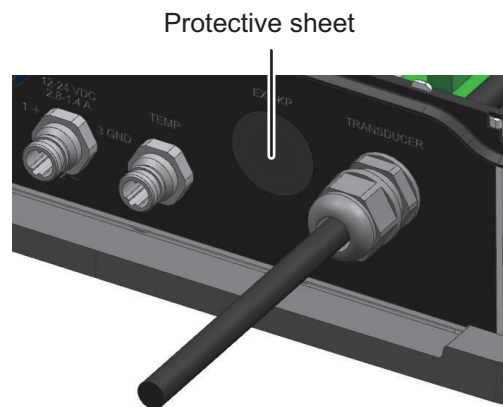

- Unfasten the sealing nut and lock nut from the supplied super gland. As shown below, pass the cable through the sealing nut, super gland, hole in the unit and the lock nut.

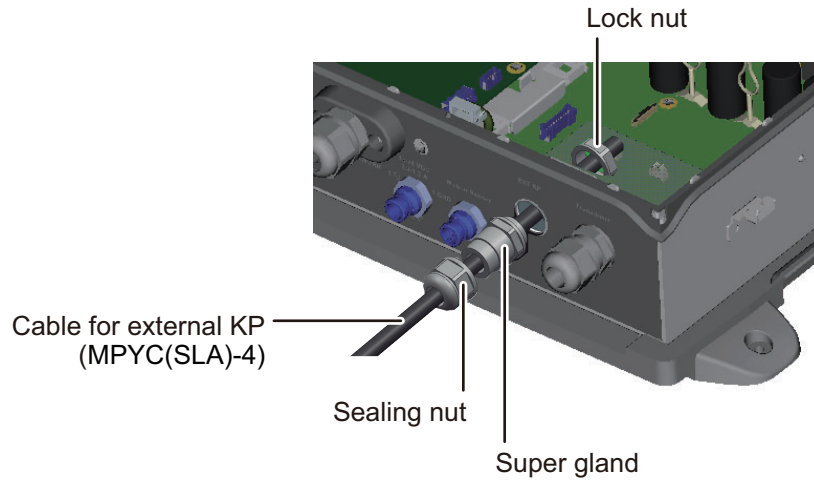

- Fasten the lock nut to fix the super gland to the unit.
- Fasten the sealing nut into the super gland. The gap between the sealing nut end and the super gland should be 4 mm. The fastening torque is 1.8 - 2.0 N m.



- Position the cable so its vinyl sheath lies in the cable clamp. Use the supplied cable clamping plate to secure the cable.

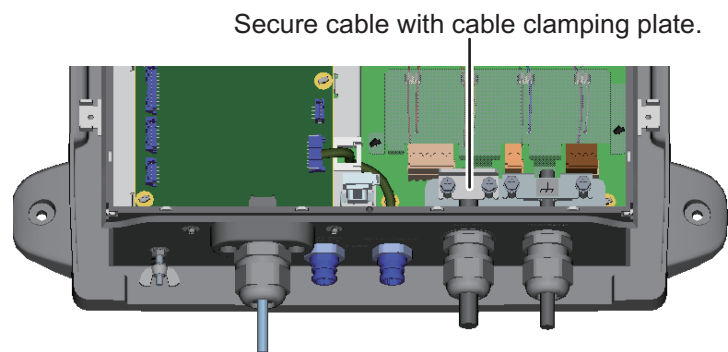

## 2. WIRING

9. Connect the KP cable. Pass the PH connector through the clamp shown below, then connect it to J9 on the DIGI board. Make sure the cable does not contact the WAGO connector (TB3). Also, secure the shield of the external KP cable to the plate where the transducer cable is fixed.

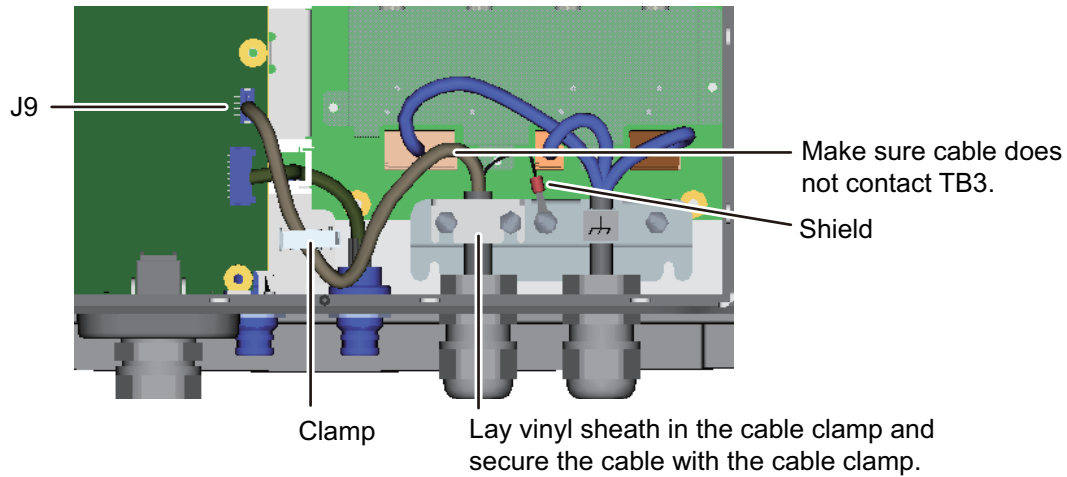

**Note 1:** As shown in the figure below, pass the cable through the cable saddle. Make sure the crimp connectors are not clamped by the cable saddle.

**Note 2:** Confirm that the direction of the clamping plate is as shown below.

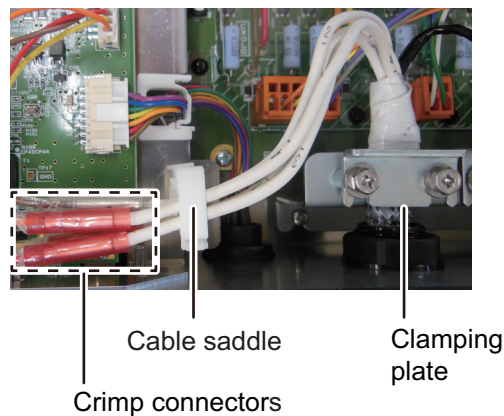

10. Attach the supplied EMI core (GRFC-10) to the cable for the external KP, approx. 10 mm from the super gland.

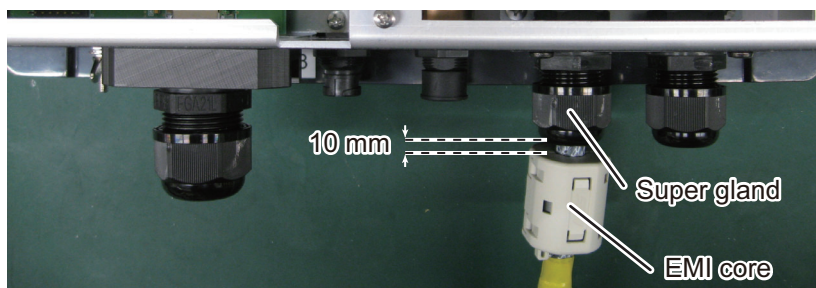

11. Reattach the inner and outer covers.



## 2.4 LAN Cable

Do as follows to connect the supplied LAN cable (MOD-Z072-050+) or the optional LAN cable (MOD-Z072-020+, MOD-Z072-100+).

1. Unfasten the sealing nut from the LAN connector then remove the sealing insert and clamping claw.
2. Detach the sealing insert from the clamping claw as shown below.

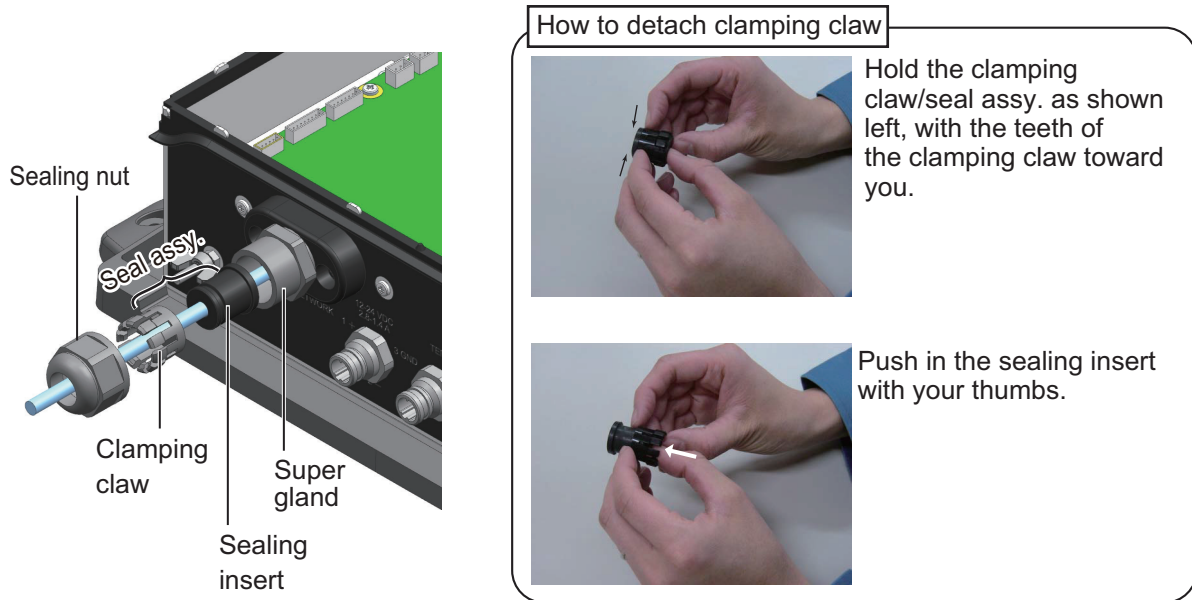

3. Pass the sealing nut, clamping claw and sealing insert onto the LAN cable in the order shown in the figure below. Connect the cable to the LAN connector. (Note the orientation of the sealing insert when passing it onto the cable. Push the cable into the slit in the sealing insert.)

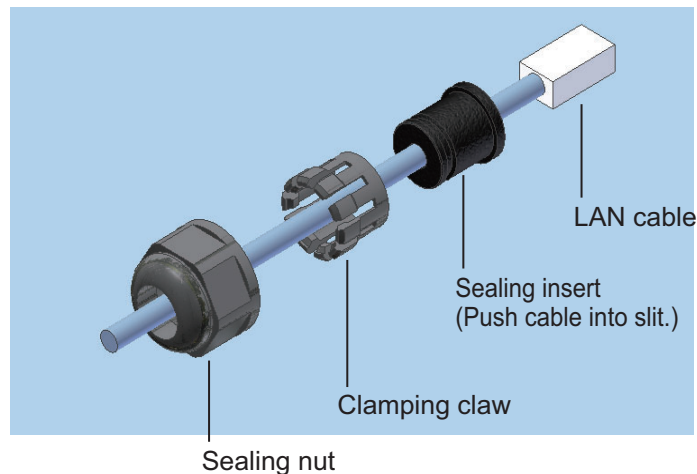

4. Set the sealing insert and clamping claw into the sealing nut then tighten the nut.

## 2. WIRING

5. Fasten the sealing nut to fasten the LAN cable. The clearance between the sealing nut and the super gland shall be 3 mm. The fastening torque for the sealing nut is 1.8 - 2.0 Nm.

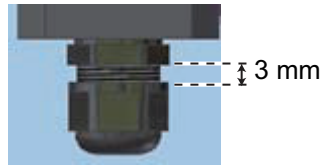

### **How to disconnect the LAN cable**

Loosen the two screws on the gland to access the cable's connector. A lock washer is fitted to the gland, so the screws cannot be unfastened completely.

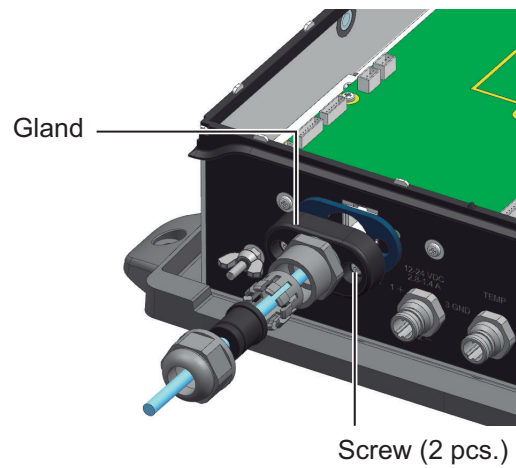

# 3. INITIAL SETTINGS

**⚠ WARNING**

 Do not open the equipment unless totally familiar with electrical circuits.

Only qualified personnel are permitted to work inside the equipment.

## 3.1 DIP Switch Setting

The DIP switches S2 and S3 should be left in the default position (OFF).

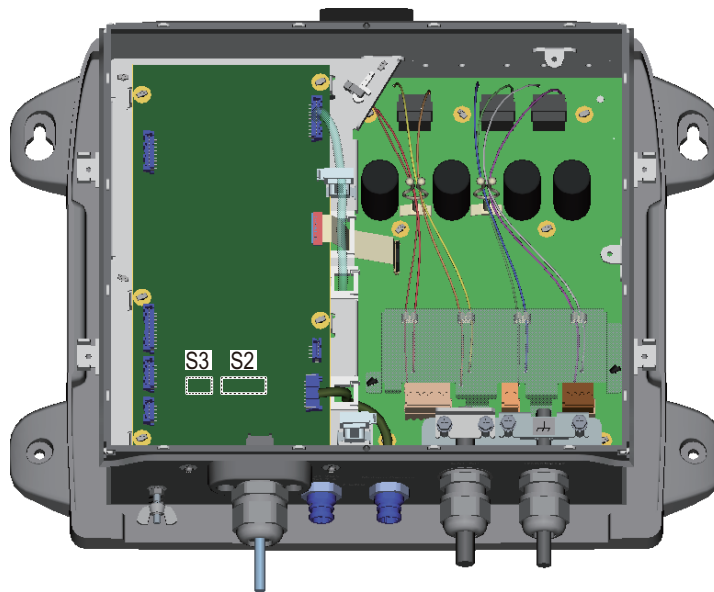

DIP switch S2

1	2	3	4	5	6	7	8
OFF							

DIP switch S3

1	2	3	4
OFF			

### 3. INITIAL SETTINGS

*DIP switch S2 setting options (reference only)*

Switch No.	Function	Setting
1	Automatic IP address assignment	<b>OFF:</b> Fixed (static) IP address. Set the IP address with switch #2. <b>ON:</b> IP address assigned automatically.
2	IP address no.	Effective when #1 segment is OFF. (See the table below for IP address. Currently, this function has no use.)
3	Restore default settings (other than LAN)	See section 5.3.
4	Restore ALL default settings	See section 5.3.
5 - 6	Keep these switches in the OFF position.	
7	No use.	
8	No use.	

#2	Host name	IP address
OFF	ES092021	172.031.092.021
ON	ES092022	172.031.092.022

After setting up the transducer for the DFF3D, set the transducer type at the NavNet device (NavNet TZtouch/NavNet TZtouch2). See respective Installation Manual for the procedure.

## 3.2 Operation Check

After connecting the NavNet TZtouch/NavNet TZtouch2, power the unit on/off from the ship's switchboard. The LED on the cover of the DFF-3D lights or flashes according to equipment state, as described in the table below.

### LED state and meaning

LED state	Meaning
Lit continuously	Standby state. (If no signal is received via LAN for more than 10 minutes, the equipment automatically goes into standby to lessen power consumption.)
Blinking every two seconds	Normal operation

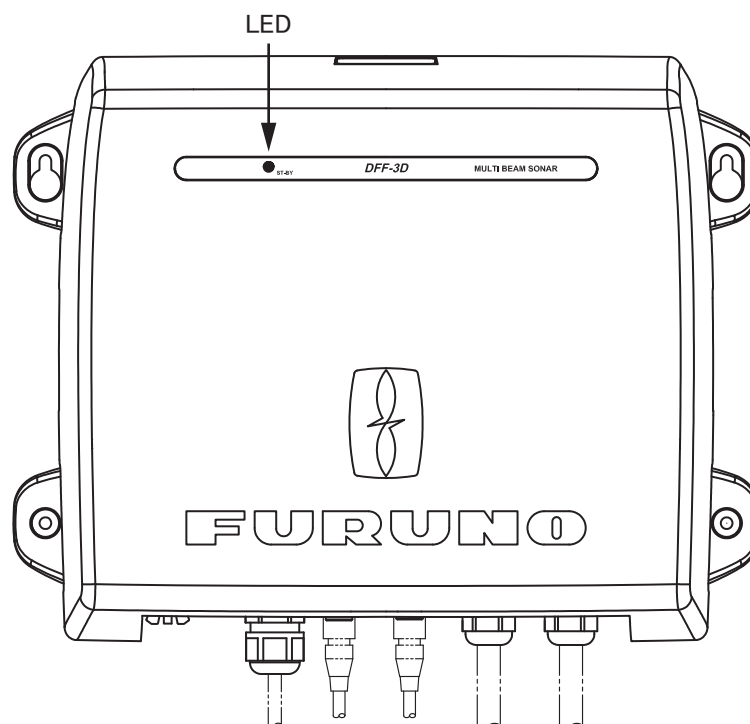

### 3.3 Multi Function Display Initial Settings

**How to open the menu**

**NavNet TZtouch:**

1. Push the Home button (or tap the home icon) to display the menu icon bar.
2. Select [Menu], [Multibeam Sonar].
3. Enter initial settings referring to the table below.

**NavNet TZtouch2:**

1. Tap the Home icon to go to the home screen.
2. Select [Settings], [Multibeam Sonar].
3. Enter initial settings referring to the tables that follow.

**Multibeam Sonar menu**

Menu item	Description	Options (setting range)
[Transducer Draft]	Set the distance between the transducer and the draft line to show the distance from the sea surface.	[0.0m] to [99.9m]
[Salt Water]	Select [ON] to use this equipment in salt water.	[OFF], [ON]
[Transducer Setup]	Set page 3-6 "Transducer Setup".	
[Transmission Power Auto]	Turn on to automatically adjust transmission power to display the seabed echo properly.	[OFF], [ON]
[Transmission Power]	Set the TX power level manually. Interference may appear on your display when a sonar of the same frequency as yours is being operated on a vessel nearby. When this occurs, lower the transmission power and request the nearby vessel to lower its sonar's TX power to reduce the interference. The setting range is 0 to 10 and 10 is maximum power.	[0] to [10]
[External KP]	Select [ON] to synchronize with external sounder's keying pulse.	[ON], [OFF]
[Bottom Level]	The default bottom level setting (0) determines that two strong echoes received in sequence are seabed echoes. If the depth indication is not stable in the default setting, adjust the bottom level here. If you can not discriminate the fish near the seabed from the seabed echo, increase the bottom level.	[-40] to [40]
[Auto Gain Offset (Multi Sounder)], [Auto Gain Offset (Side Scan)], [Auto Gain Offset (Cross Section)]	In the auto mode, lower or raise the gain as necessary.	[-5] to [5]

Menu item	Description	Options (setting range)
[STC (Side Scan)], [STC (Multi Sounder)]	STC reduces surface layer noise, to discriminate surface fish from surface layer noise. [0] is OFF and [10] reduces noise approx. 5 m from the transducer. Too high a setting may erase wanted fish echoes.	[0] to [10]
[TX Pulse]	<p>The pulse length is automatically set according to range. Use a short pulse for better resolution and a long pulse when detection range is important. To improve resolution on the side scan display, etc., use [Short 1] or [Short 2].</p> <ul style="list-style-type: none"> <li>• [Short 1] improves the detection resolution, but the detection range is shorter than with [Std] (pulse length is 1/4 of [Std]).</li> <li>• [Short 2] raises the detection resolution, however detection range is shorter (pulse length is about 1/2 of ([Std]) than [Std]).</li> <li>• [Std] is the standard pulse length, and is suitable for general use.</li> <li>• [Long] increases the detection range but lowers the resolution (about 1/2 compared to the [Std] pulse length)</li> </ul>	[Short1], [Short2], [Standard], [Long]
[DFF-3D Monitoring]	Display pitch and roll (measured by internal sensor) and B voltage.	
[Set Hardware to Factory Default]	Reset the external fish finder to its factory default settings.	[OK], [Cancel]
[Restore Default Settings]	Restore all menu settings to default.	[OK], [Cancel]

### 3. INITIAL SETTINGS

#### Transducer Setup menu

For the oscillation center see "Motion Sensor menu" on the next page.

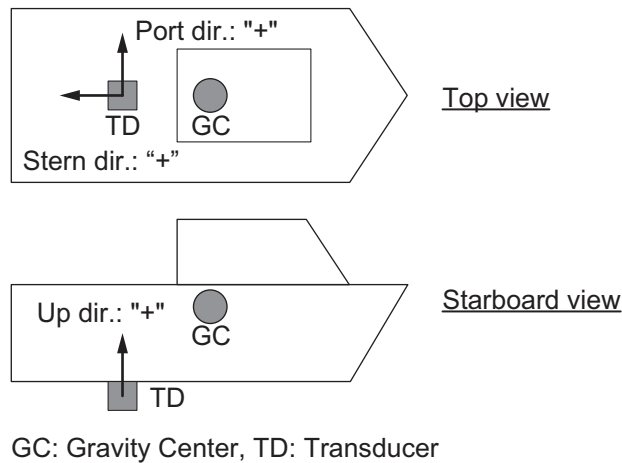

If the center of gravity is not known, see the drawing below.

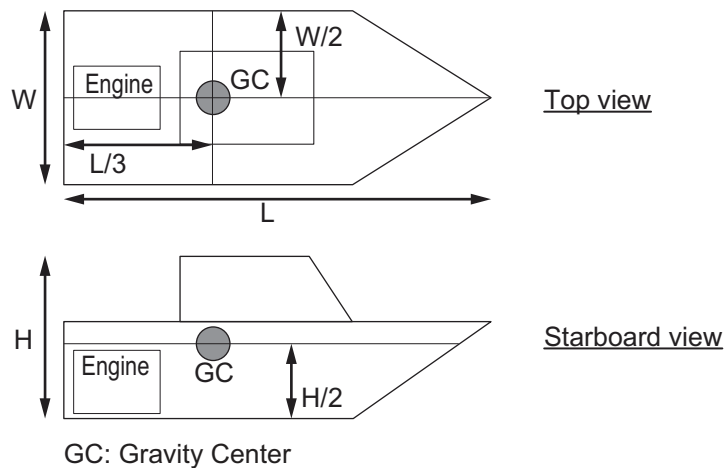

**Note:** The location of the center of gravity may be different than as shown in the figures above, depending on hull shape, engine position and the installation status of other equipment.

Menu item	Description	Options (setting range)
[Transducer Mis-mount Correction]	Set to [ON] if the transducer is installed facing the stern.	[ON], [OFF]
[Transducer Position Bow/Stern]	Set the distance from the transducer to the ship's center of gravity in the bow/stern direction. For stern location, set a positive value.	-100.0 to 100.0 (m)
[Transducer Position Up/Down]	Set the distance from the transducer to the ship's center of gravity in the up/down (vertical) direction. For upward location, set a positive value.	-100.0 to 100.0 (m)
[Transducer Position Port/Starboard]	Set the distance from the transducer to the ship's center of gravity in the port/starboard direction. For port location, set a positive value.	-100.0 to 100.0 (m)



**Motion Sensor menu**

Select [Transducer Setup] on the [Multibeam Sonar] menu to show the [Motion Sensor] menu (below the [Transducer Setup] menu).

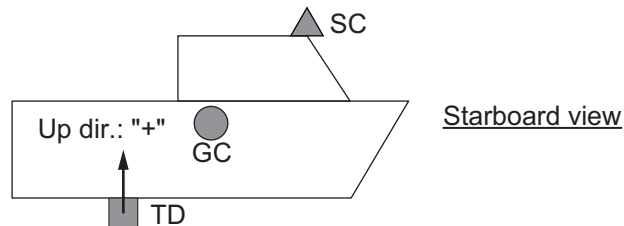
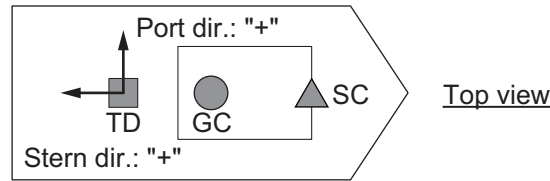

GC: Gravity Center, TD: Transducer, SC: Satellite Compass

If the center of gravity is not known, see the drawing below.

GC: Gravity Center, TD: Transducer

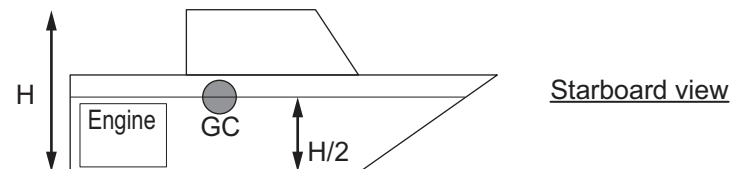
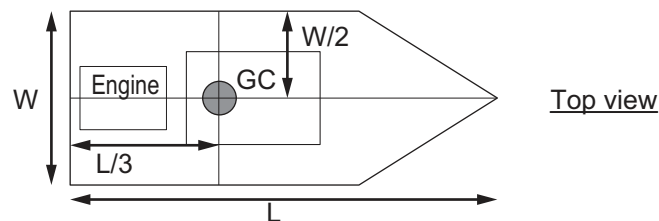

GC: Gravity Center

**Note:** The location of the center of gravity may be different than as shown in the figures above, depending on hull shape, engine position and the installation status of other equipment.

Menu item	Description	Options (setting range)
[Motion Sensor Source]	Select the sensor connected to you NavNet TZtouch2 unit.	[SC], [Internal], [OFF]
[Motion Sensor Pos. Bow/Stern]	Set the distance from the transducer to the motion sensor in the bow-stern direction. For the stern side, set a positive value. <b>Note:</b> This menu appears if the motion sensor source is selected to [SC].	-100 to 100.0 (m)

### 3. INITIAL SETTINGS

Menu item	Description	Options (setting range)
[Motion Sensor Pos. Up/Down]	Set the distance from the transducer to the motion sensor in the up/down (vertical) direction. Use a "+" value for upward direction. <b>Note:</b> This menu appears if the motion sensor source is selected to [SC].	-100 to 100.0 (m)
[Motion Sensor Pos. Port/Starboard]	Set the distance from the transducer to the motion sensor in the port-starboard direction. For port location, set a positive value. <b>Note:</b> This menu appears if the motion sensor source is selected to [SC].	-100 to 100.0 (m)
[GPS Sensor Pos. Bow/Stern]	Set the distance from the transducer to the GPS sensor in the bow-stern direction. For stern location, set a positive value.	-100 to 100.0 (m)
[GPS Sensor Pos. Up/Down]	Set the distance from the transducer to the GPS sensor in the up/down (vertical) direction. Use a "+" value for upward direction.	-100 to 100.0 (m)
[GPS Sensor Pos. Port/Starboard]	Set the distance from the transducer to the GPS sensor in the port-starboard direction. For port location, set a positive value.	-100 to 100.0 (m)
[Roll Sensor Offset]	Set the roll offset to use with the internal motion sensor.	-45.0 to 45.0
[Pitch Sensor Offset]	Set the pitch offset to use with the internal motion sensor.	-45.0 to 45.0
[Motion Sensor Time Lag (in ms)]	Set the time lag to use with the external motion sensor. <b>Note:</b> This menu appears if the motion sensor source is selected to [SC].	0 to 400
[Heading Sensor Time Lag (in ms)]	Set the time lag for the data received from the position sensor.	0 to 3500
[Position Sensor Time Lag (in ms)]	Set the time lag for the data received from the position sensor.	0 to 3500

#### **Sync (time lag) setting**

- If the equipment is connected as shown below, no adjustment to the time lag settings is necessary.

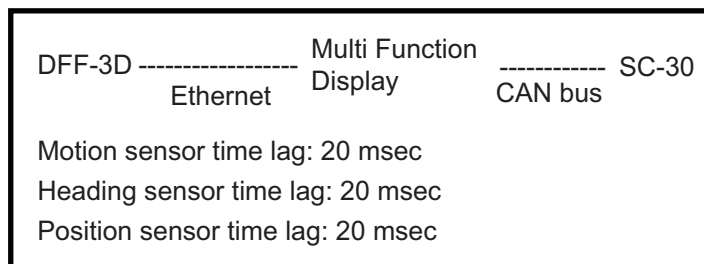

- If the equipment is connected as shown in the figure below, change the time lag settings as indicated.

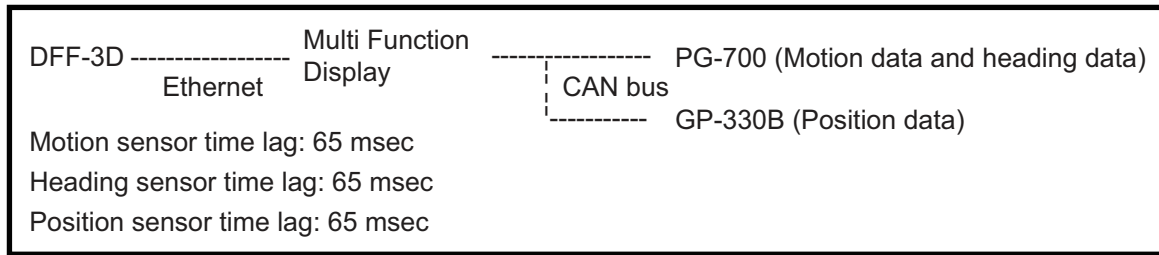

- If the connection is different from those mentioned here, calculate the time lag for each sensor and enter them accordingly, using the following formula.  
Time lag = Transmission delay + Propagation delay

**Transmission delay:** Delay required for calculation and output by the motion sensor, heading sensor, and position sensor.

SC-30: Use 5 msec for the calculation.

PG-700: Use 50 msec for the calculation.

GP-330B: Use 50 msec for the calculation.

**Propagation delay:** Time required for the data to reach the DFF-3D, via repeater and data route. For the multi function display connected by CAN bus, use 15 msec for the calculation. If NMEA data is fed to the DFF-3D via the NMEA Data Converter (IF-NMEA2K2), set the calculation figure according to the baud rate between the sensor and the IF-NMEA2K2 as shown below.

38400 bps: Use 40 msec for the calculation.

4800 bps: Use 145 msec for the calculation.

For example, the sensor feeding data to the multi function display via the IF-NMEA2K2 has a transmission delay of 30 msec and a baud rate of 38400 bps. Then, the time lag would be as shown in the calculation below.

Time lag 70 msec = Transmission delay 30 msec + Propagation delay 40 msec

### 3. INITIAL SETTINGS

This page is intentionally left blank.

# 4. OPERATION

This chapter describes the display and operations for the Multi Beam Sonar. For basic operations with the NavNet TZtouch multi function display, such as touch operations and power on/off, see the Operator's Manual for the NavNet TZtouch.

The DFF-3D has four display screens (modes), multi sounder, side scan, cross section, and 3D sounder history.

## 4.1 Display Screens Overview

### Multi-sounder display

Tap the multi-sounder display icon on the home screen to show the multi-sounder display.

The multi-sounder display operates similar to the conventional fish finder, providing information about the seabed and underwater conditions. The video display scrolls from the right to left with the passing of time.

The echoes appearing at the right edge of the display are the latest echoes. Echoes from individual fish, schools of fish and the seabed are shown. With the gain set properly, the distance to the seabed appears on the screen.

The gain, clutter suppressor and TVG are adjusted according to the mode selected, auto fishing or auto cruising. Manual adjustment of those controls is also possible.

The single beam presentation displays the information detected by the downward-looking beam. The triple beam presentation displays the information detected by the port beam, starboard beam, and downward-looking beam.

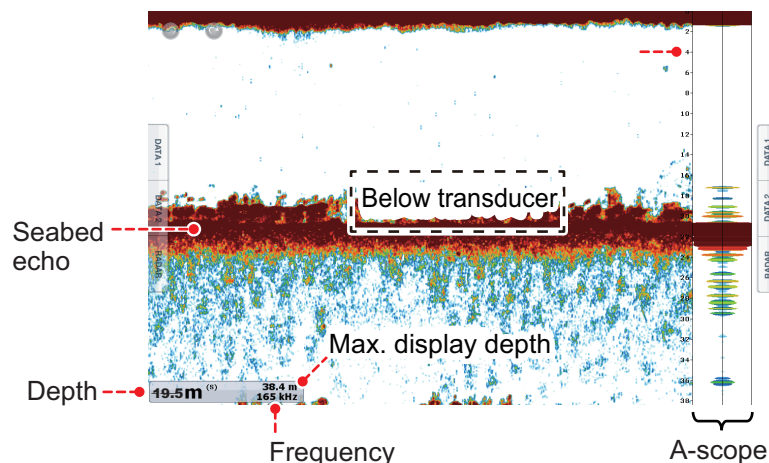

*Single beam display*

#### 4. OPERATION

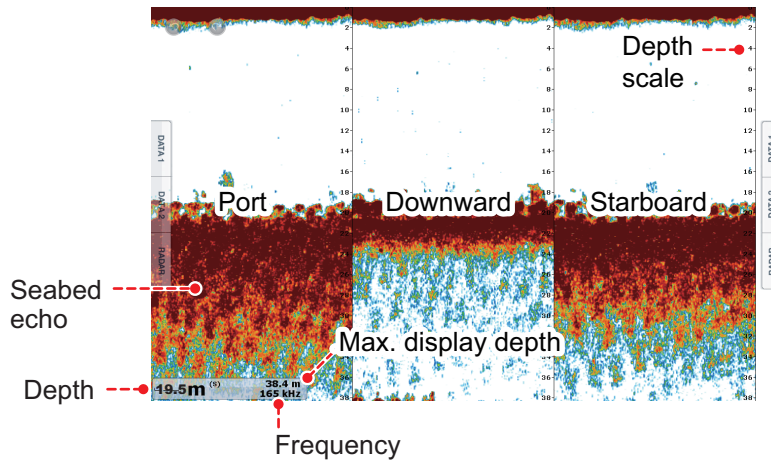

*Triple beam display*

#### **Side scan display**

Tap the side scan display icon on the home screen to show the side scan display.

The side scan display shows the echoes received from the port and starboard directions.

The side scan display starts from the center of the vessel, and traces in the port and starboard directions. The most recent echoes are at the top of the screen and the oldest are at the bottom of the screen.

The side scan display is different from the other modes employed by this equipment - it clearly displays the shape of echoes (fish bed, etc.).

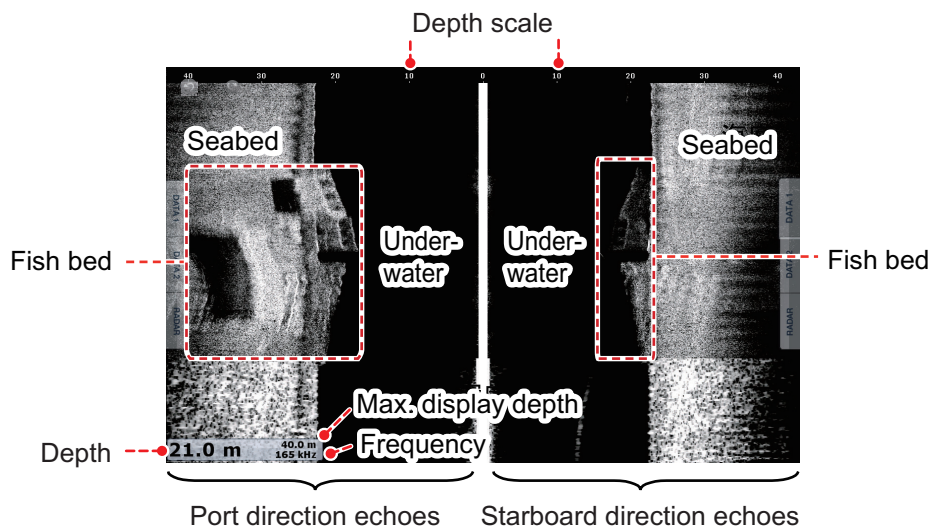

**Cross section display**

Tap the cross section display icon on the home screen to show the cross section display.

The cross section display, shows seabed and underwater conditions.

This multi beam sonar uses a 120° beam (downward to port 60°; downward to starboard 60°), providing highly accurate underwater images.

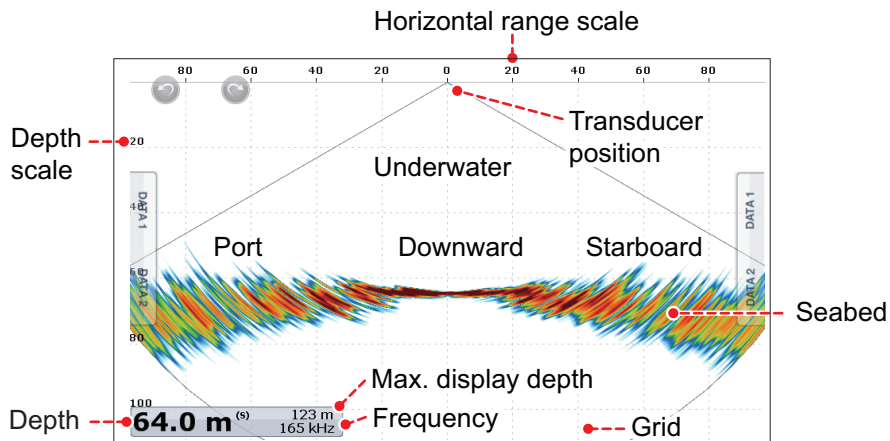
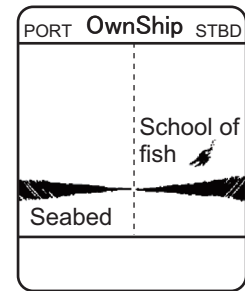
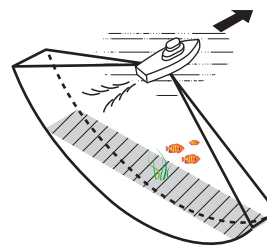

**3D sounder history display**

Tap the 3D sounder history display icon on the home screen to show the D sounder history display.

The 3D sounder history provides a 3D graphic of the past seabed and underwater echoes detected by your vessel. The display can be used to detect schools of fish.

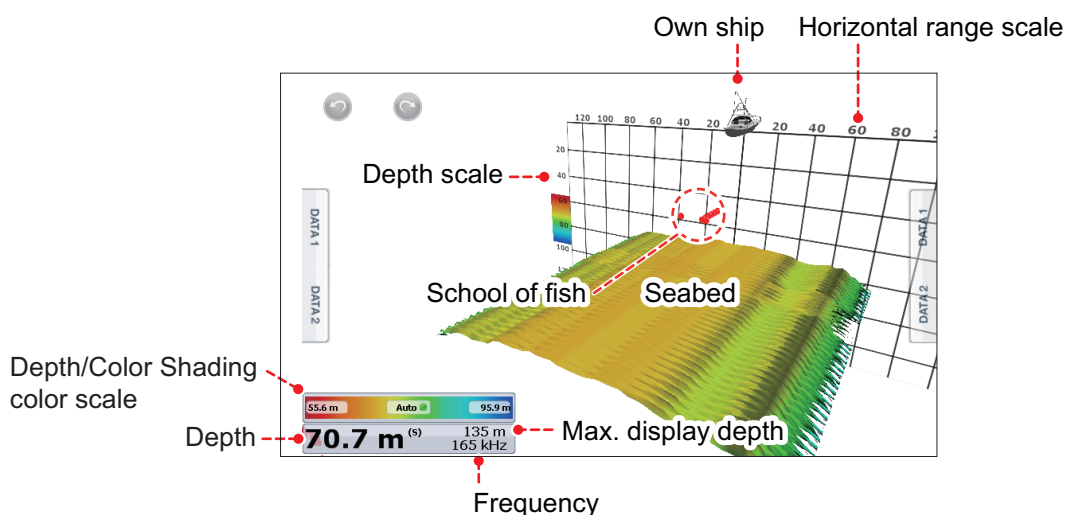

## 4.2 Multi-Sounder Display Operations

This section covers the functions available with the multi-sounder display. For the menu items shared with the conventional fish finder, see the applicable Operator's Manual.

### 4.2.1 How to switch between TX and STBY

Tap the multi-sounder display to show the pop-up menu. Select [TX] to start transmitting. [ST-BY] appears at the center of the screen when transmission is stopped.

### 4.2.2 How to switch between single beam and triple beam presentations

1. Tap the multi-sounder display to show the pop-up menu.
2. Select [Mode].
3. Select [Single Beam] or [Triple Beam] as required.
4. Select [Close] to close the pop-up menu.

### 4.2.3 How to set the TX beam angle

You can set the TX beam angle for the port, starboard and downward beams.

1. Tap the multi-sounder display to show the pop-up menu.
2. Select [Beam Angle].
3. Set the beam angle as required.

### 4.2.4 How to set the TX beam width

You can set the TX beam width for the port, starboard and downward beams.

1. Tap the multi-sounder display to show the pop-up menu.
2. Select [Beam Width].
3. Set the beam width as required.

### 4.2.5 How to show or hide the scale box

The scale box, shown at the bottom left corner on the display, shows depth, current range, and TX frequency. You can show the box as follows.

1. Tap the multi-sounder display to show the pop-up menu.
2. Select [Scale Box] to show the scale box.



## 4.2.6 Availability of points and event marks registration, and go to a point

For how to register points and event marks, see the NavNet TZtouch or NavNet TZtouch2 manual.

The table below shows function availability according to latitude/longitude, heading data presence or absence. If there is no latitude/longitude data, none of the functions below are available.

For NavNet TZtouch or NavNet TZtouch2, input PGN data. The PGN data available is as shown below.

### Latitude/longitude data

- 129025 Position, Rapid Update
- 129029 GNNS Position Data

### Heading data

- 127237 Heading/Track Control
- 127250 Vessel Heading
- 130577 Direction Data

### Latitude/Longitude / Heading data: YES

Item	Starboard	Downward	Port
Point registration	Yes	Yes	Yes
Go to point	Yes	Yes	Yes
Event mark registration	Yes	Yes	Yes

### Latitude/Longitude: YES, Heading data: NO

Item	Starboard	Downward	Port
Point registration	No	Yes	No
Go to point	No	Yes	No
Event mark registration	Yes	Yes	Yes

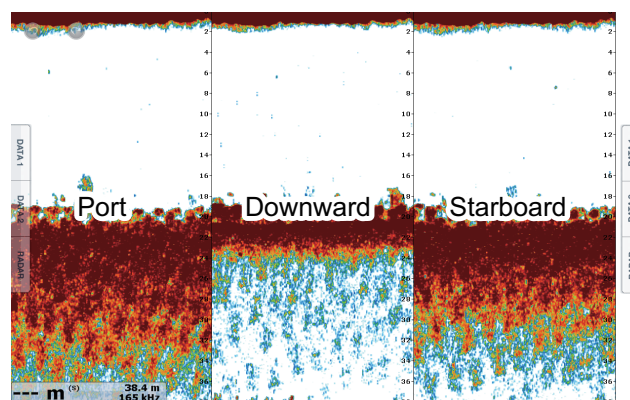

## 4.3 Side Scan Display Operations

This section covers the functions available with the side scan display. For the menu items shared with the conventional fish finder, see the applicable Operator's Manual.

### 4.3.1 How to switch between TX and STBY

Tap the side scan display to show the pop-up menu. Select [TX] to start transmitting. [ST-BY] appears at the center of the screen when transmission is stopped.

### 4.3.2 How to change echo color

1. Select [Menu] from the menu icon bar to show the menu.
2. Select [Multibeam Sonar].
3. Select [Echo Color].
4. Select [White], [Blue] or [Brown] as required.
5. Select [Close] to close the pop-up menu.

### 4.3.3 How to show or hide the scale box

The scale box, shown at the bottom left corner on the display, shows depth, current range, and TX frequency. You can show the box as follows.

1. Tap the side scan display to show the pop-up menu.
2. Select [Scale Box] to show the scale box.

#### 4.3.4 Availability of points and event marks registration, and go to a point

For how to register points and event marks, see the NavNet TZtouch or NavNet TZtouch2 manual.

The table below shows function availability according to latitude/longitude, heading data presence or absence. If there is no latitude/longitude data, none of the functions below are available.

For NavNet TZtouch or NavNet TZtouch2, input PGN data. The PGN data available is as shown below.

##### Latitude/longitude data

- 129025 Position, Rapid Update
- 129029 GNNS Position Data

##### Heading data

- 127237 Heading/Track Control
- 127250 Vessel Heading
- 130577 Direction Data

##### Latitude/Longitude / Heading data: YES

Item	Starboard	Port
Point registration	Yes	Yes
Go to point	Yes	Yes
Event mark registration	Yes	Yes

##### Latitude/Longitude: YES, Heading data: NO

Item	Starboard	Port
Point registration	No	No
Go to point	No	No
Event mark registration	Yes	Yes

## 4.4 Cross Section Display Operations

This section covers the functions available with the cross section display. For the menu items shared with the conventional fish finder, see the applicable Operator's Manual.

### 4.4.1 How to switch between TX and STBY

Tap the cross section display to show the pop-up menu. Select [TX] to start transmitting. [ST-BY] appears at the center of the screen when transmission is stopped.

### 4.4.2 How to show or hide the grid

The grid, which is useful for measuring the distance to a target, can be shown or hidden as follows.

1. Tap the cross section display to show the pop-up menu.
2. Select [Grid] to show the grid.

### 4.4.3 Zoom display

The seabed echo can be zoomed.

1. Tap the cross section display to show the pop-up menu.
2. Select [Zoom] to zoom the seabed echo. Select [Zoom] again to restore the normal display.

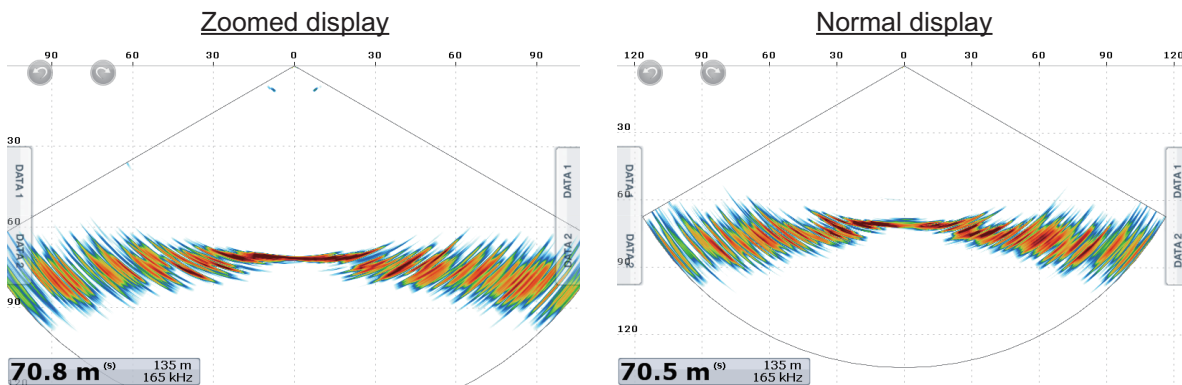

### 4.4.4 How to smooth echoes (distance)

If echoes are "disconnected" because of an undulating seabed, change the setting to [Low], [Medium] or [High] as necessary. Smoothing is done in the range direction to smooth the echo presentation.

1. Select [Menu] from the menu icon bar to show the menu.
2. Select [Multibeam Sonar].
3. Select [Echo Smoothing (Distance)].
4. Select [Low], [Medium] or [High] as required. The default setting is [Medium]. Select [OFF] to stop smoothing.
5. Select [Close] to close the pop-up menu.

#### 4.4.5 How to smooth echoes (time)

If echoes are difficult to see because they appear "speckled," use the echo smoothing feature to suppress the speckling by time.

1. Select [Menu] from the menu icon bar to show the menu.
2. Select [Multibeam Sonar].
3. Select [Echo Smoothing (Time)].
4. Select [Low], [Medium] or [High] as required. The default setting is [Medium]. Select [OFF] to stop smoothing.
5. Select [Close] to close the pop-up menu.

#### 4.4.6 How to apply correction to the speed of sound

Even though the sea bottom is flat, the left or right edge, up or down may be distorted. To compensate for this problem, adjust the speed of sound.

##### **Manual correction**

1. Select [Menu] from the menu icon to show the menu.
2. Select [Multibeam Sonar].
3. Select [Sound Speed Correction], then enter a correction. The setting range is -200 to +200.
4. Select [Close] to close the menu.

##### **Automatic correction**

1. Select [Menu] from the menu icon to show the menu.
2. Select [Multibeam Sonar].
3. Select [Temp.-based Correction], then select [ON].  
Select [OFF] to remove the correction.
4. Select [Close] to close the menu.

#### 4.4.7 How to show or hide the scale box

The scale box, shown at the bottom-left corner on the display, shows depth, current range, and TX frequency. You can show the box as follows.

1. Tap the cross section display to show the pop-up menu.
2. Select [Scale Box] to show the scale box.

### 4.4.8 Availability of points and event marks registration, and go to a point

For how to register points and event marks, see the NavNet TZtouch or NavNet TZtouch2 manual.

The table below shows function availability according to latitude/longitude, heading data presence or absence. If there is no latitude/longitude data, none of the functions below are available.

For NavNet TZtouch or NavNet TZtouch2, input PGN data. The PGN data available is as shown below.

Latitude/longitude data

- 129025 Position, Rapid Update
- 129029 GNNS Position Data

Heading data

- 127237 Heading/Track Control
- 127250 Vessel Heading
- 130577 Direction Data

Latitude/Longitude / Heading data: YES

Item	Cross section
Point registration	Yes
Go to point	No
Event mark registration	Yes

Latitude/Longitude: YES, Heading data: NO

Item	Starboard
Point registration	No
Go to point	No
Event mark registration	Yes

## 4.5 3D Sounder History Display Operations

This section covers the functions available with the 3D sounder history display. For the menu items shared with the conventional fish finder, see the applicable Operator's Manual.

### 4.5.1 How to switch between TX and STBY

Tap the 3D sounder history display to show the pop-up menu. Select [TX] to start transmitting. [ST-BY] appears at the center of the screen when transmission is stopped.

### 4.5.2 How to move, zoom in, zoom out the viewpoint position

#### How to move the viewpoint

The viewpoint can be moved by dragging.

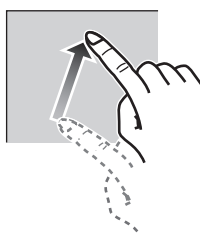

#### How to zoom in, zoom out

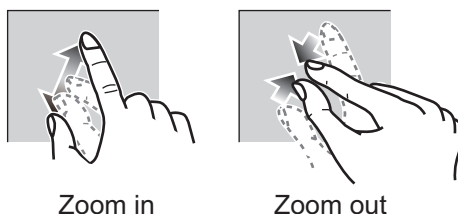

#### How to restore default view

If you get lost in viewpoint or zoom, you can restore the default view as follows.

1. Tap the 3D sounder history display to show the pop-up menu.
2. Select [Default View] to show the depth/frequency box.

### 4.5.3 How to mark school of fish

A detected school of fish can be marked with a "dot" mark for easy identification.

1. Tap the 3D sounder history display to show the pop-up menu.
2. Select [Fish School Icon] to mark the detected school of fish with the dot mark.

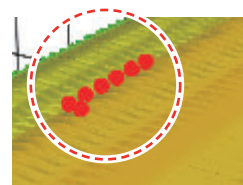

### 4.5.4 How to stop advancement of the display

You can stop advancement of the history display to observe the distribution of sea floor topography and school of fish.

1. Tap the 3D sounder history display to show the pop-up menu.
2. Select [Pause] to stop the display.

### 4.5.5 How to adjust the echo detection level

Adjust the echo detection level if schools of fish are detected unstably.

1. Select [Menu] from the menu icon to show the menu.
2. Select [Multibeam Sonar].
3. Select [Fish Detection Level].
4. Select [Low], [Medium] or [High] as required. The default setting is [Medium]. If too many schools of fish are being detected, select [Low]. If too few schools are detected, select [High].
5. Select [Close] to close the menu.

### 4.5.6 How to calibrate the seabed echo

If schools of fish or a fish reef are detected and displayed as the seabed echo, adjust the strength of the seabed echo as shown below to correctly identify the seabed echo.

1. Select [Menu] from the menu icon to show the menu.
2. Select [Multibeam Sonar].
3. Select [Seabed Echo Calibration]. Drag the slider bar to adjust.  
The setting range is -15 to +15. A large figure helps distinguish bottom fish from the seabed echo; however, it is difficult to distinguish a fish bed. Use a small figure to distinguish a fish bed; however, it is difficult to distinguish bottom fish from the seabed echo.
4. Select [Close] to close the menu.

### 4.5.7 How to use the noise filter

If the seabed echo is displayed with undulations, use the noise filter to smooth the seabed echo.

1. Select [Menu] from the menu icon to show the menu.
2. Select [Multibeam Sonar].
3. Select [Noise Filter].
4. Select [Low], [Medium] or [High] as required. The default setting is [Medium].
5. Select [Close] to close the menu.



### 4.5.8 How to use terrain shading

The thickness of the shading for the seabed terrain can be adjusted.

1. Select [Menu] from the menu icon to show the menu.
2. Select [Multibeam Sonar].
3. Select [Terrain Shading]. Drag the slider bar to adjust. The default setting is 50. See the figure below for setting and resulting terrain shading

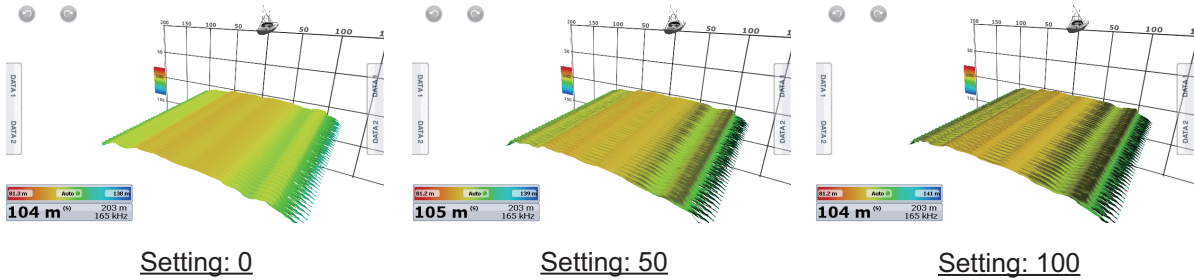

4. Select [Close] to close the menu.

### 4.5.9 Depth/Color Shading display

The seabed echo and schools of fish can be shown in shades of colors according to depth, to help you see the differences in depths more easily.

#### Color shading display

Color shading can be applied to the seabed echo or schools of fish. For the seabed display, the seabed color can be multi tone or single tone, and schools of fish can be shown in single tone or single color. For the schools of fish display, schools can be shown in multi tone or single tone and the bottom color is in a single tone.

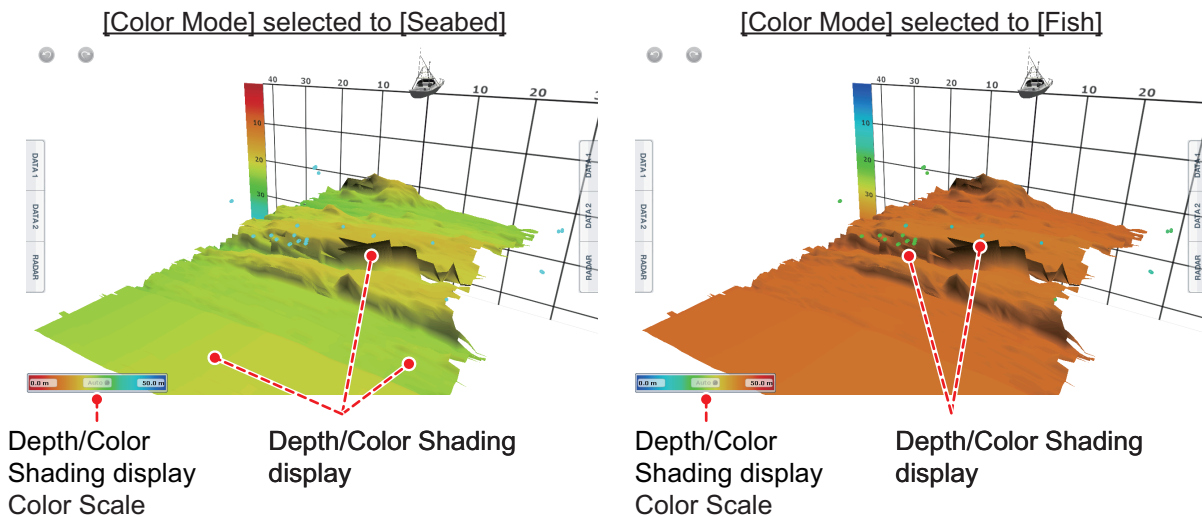

1. Tap the 3D sounder history display to show the pop-up menu.
2. Select [Color Mode].
3. Select [Seabed] or [Fish] as required.

4. OPERATION

**How to set color shading**

Open the menu, select Multi Beam to show the menu for setting color shading.

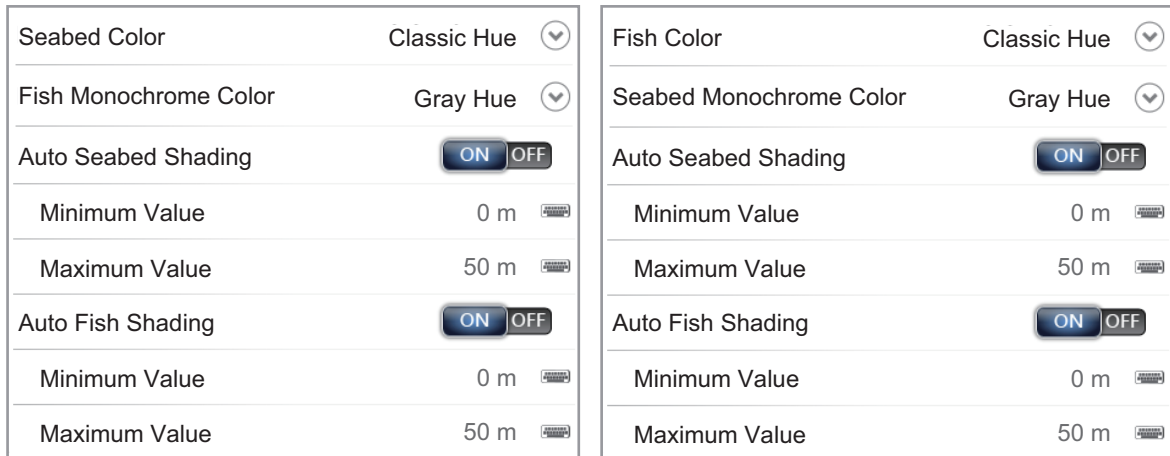



[Color Mode] selected to [Seabed]

[Color Mode] selected to [Fish]

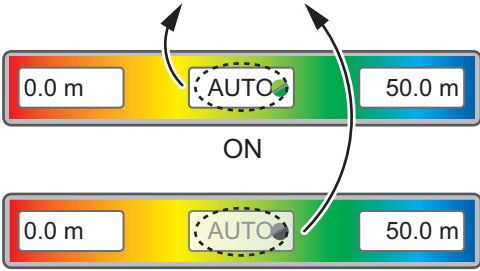
**[Color Mode] selected to [Seabed]**



Menu item	Description	Setting options
[Seabed Color]	For setting multi tone or single tone.	[Classic Hue] [Inverted Classic Hue] [Red Hue] [Blue Hue] [Green Hue] [Yellow Hue]
[Fish Monochrome Color]	For setting single tone or single color.	[Gray Hue] [Brown Hue] [Red] [Green] [Blue] [Cyan] [Magenta] [Black Or White] [Pink] [Light Green] [Yellow]
[Auto Seabed Shading]	Use automatic or manual seabed shading.  Tap here to turn the automatic seabed shading scale [ON] or [OFF].  	[ON], [OFF]

Menu item	Description	Setting options
[Minimum Value]	<p>Use the software keyboard to set the shallowest depth to use. [Auto Seabed Shading] must be OFF to enter depth. Alternatively, tap the minimum value indication on the color bar scale to show the slider bar. Drag the slider bar to set.</p>  <p>[Minimum Value] Shallowest depth value</p>	0 to 1200 (m)
[Maximum Value]	<p>Use the software keyboard to set the deepest depth to use. [Auto Seabed Shading] must be OFF to enter depth. Alternatively, tap the maximum value indication on the color bar scale to show the slider bar. Drag the slider bar to set.</p>  <p>[Maximum Value] Shallowest depth value</p>	0 to 1200 (m)

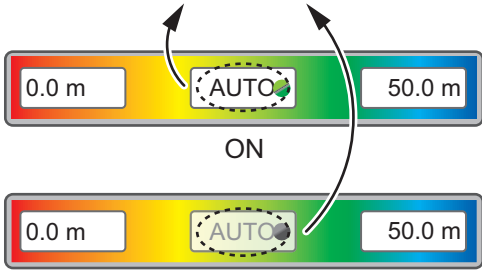
*[Color Mode] selected to [Fish]*

Menu item	Description	Setting options
[Fish Color]	For setting multi tone or single tone.	[Classic Hue] [Inverted Classic Hue] [Red Hue] [Blue Hue] [Green Hue] [Yellow Hue]
[Fish Mono-chrome Color]	For setting single tone or single color.	[Gray Hue] [Brown Hue]
[Auto Fish Shading]	<p>Use automatic or manual fish shading.</p> <p>Tap here to turn the automatic fish shading scale [ON] or [OFF].</p>  <p>ON</p> <p>OFF (AUTO is greyed out)</p>	[ON], [OFF]

#### 4. OPERATION

Menu item	Description	Setting options
[Minimum Value]	<p>Use the software keyboard to set the shallowest depth to use. [Auto Fish Shading] must be OFF to enter depth. Alternatively, tap the minimum value indication on the color bar scale to show the slider bar. Drag the slider bar to set.</p>  <p>[Minimum Value] Shallowest depth value</p>	0 to 1200 (m)
[Maximum Value]	<p>Use the software keyboard to set the deepest depth to use. [Auto Fish Shading] must be OFF to enter depth. Alternatively, tap the maximum value indication on the color bar scale to show the slider bar. Drag the slider bar to set.</p>  <p>[Maximum Value] Shallowest depth value</p>	0 to 1200 (m)

#### 4.5.10 How to show or hide the scale box

The scale box, shown at the bottom left corner on the display, shows depth, current range, and TX frequency. You can show the box as follows.

1. Tap the 3D sounder history display to show the pop-up menu.
2. Select [Scale Box] to show the scale box.

#### 4.5.11 Availability of points and event marks registration, and go to a point

For how to register points and event marks, see the multi function display operator's manual.

The table below shows function availability according to latitude/longitude, heading data presence or absence. If there is no latitude/longitude data, none of the functions below are available.

For the multi function display, input PGN data. The PGN data available is as shown below.

##### Latitude/longitude data

- 129025 Position, Rapid Update
- 129029 GNNS Position Data

##### Heading data

- 127237 Heading/Track Control
- 127250 Vessel Heading
- 130577 Direction Data

##### Latitude/Longitude / Heading data: YES

Item	Fish	Seabed	Other than Fish or Seabed
Point registration	Yes	Yes	No
Go to point	Yes	Yes	No
Event mark registration	No	No	Yes

##### Latitude/Longitude: YES, Heading data: NO

Item	Fish	Seabed	Other than Fish or Seabed
Point registration	No	No	No
Go to point	No	No	No
Event mark registration	No	No	Yes

#### 4. OPERATION

This page is intentionally left blank.

# 5. MAINTENANCE, TROUBLESHOOTING

 <b>WARNING</b>
 <p><b>ELECTRICAL SHOCK HAZARD</b> Do not open the equipment.</p> <p>Only qualified personnel are permitted to work inside the equipment.</p>

<b>NOTICE</b>
<p><b>Do not apply paint, anti-corrosive sealant or contact spray to coating or plastic parts of the equipment.</b></p> <p>Those items contain organic solvents that can damage coating and plastic parts, especially plastic connectors.</p>

## 5.1 Maintenance

Regular maintenance is essential for good performance. Check the items listed in the table below at the suggested interval to help keep your equipment in good shape for years to come.

Item	Check point, action	Check interval
Cable condition	Check that cables are not damaged. Replace if damaged.	Once a month
Cable connector	Check that the connector of each cable is tightly fastened and not damaged. Refasten if necessary. Replace if damaged.	Once a month
Ground terminal, ground wire	Check for corrosion. Clean if necessary. Replace ground wire if damaged.	Once a month
Power supply voltage	Check voltage. If out of rating correct problem.	Once a month
Cabinet cleanliness	Dust or dirt on the cabinet may be removed with a dry cloth. Do not use chemical-based cleaners to clean the cabinet; they can remove markings and damage the cabinet.	Once a month
Transducer	Marine life on the transducer face will result in a gradual decrease in sensitivity. Check the transducer face for cleanliness each time the boat is removed from the water. Carefully remove any marine life with a piece of wood or fine-grade sandpaper.	When the vessel is removed from the water.

## 5.2 How to Replace the Fuse

The 5 A fuse (Type: FGBO-A 125V 5A PBF, Code No. 000-155-853-10) in the snap-in fuse holder on the power cable protects the equipment from equipment fault and reverse polarity of the power supply. If the equipment cannot be powered, the fuse may have blown. Find out the cause for the blown fuse before replacing the fuse. If the fuse blows again after replacement, contact a FURUNO agent or dealer for instructions.

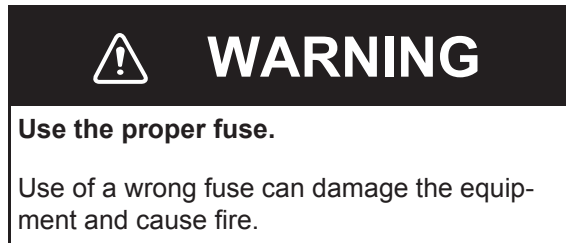

## 5.3 How to Restore Default Settings

This procedure restores all default multibeam sonar settings on the NavNet TZtouch/ NavNet TZtouch2 device. You can restore all default settings or restore those other than LAN. This procedure should only be performed by a suitably qualified FURUNO technician.

1. Disconnect the power and LAN cables from the DFF-3D.
2. Open the outer cover and shield cover. Turn on the #3 or #4 switch of DIP Switch S2 as applicable.  
#3: Restore default settings (IP address, etc.) except LAN related.  
#4: Restore all default settings. Use this when changing transducers.
3. Connect the power cable to the DFF-3D, then turn on the power at the ship's switchboard.  
If #4 of DIP Switch S2 is set to ON, the LED blinks every 0.4 seconds.
4. Set up the transducer at the NavNet equipment, referring to chapter 3.



# APPENDIX 1 MENU TREE

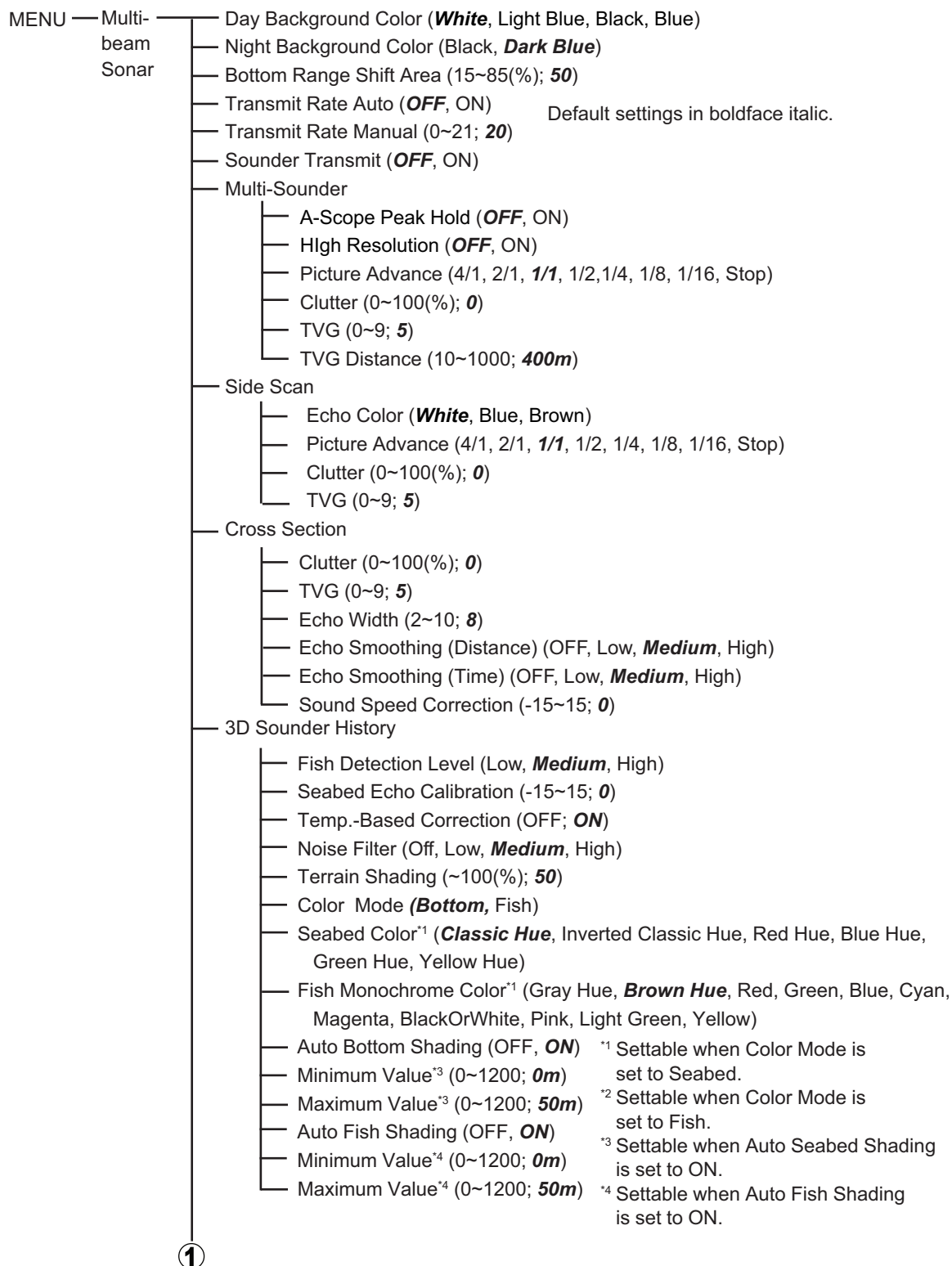

# APPENDIX 1 MENU TREE

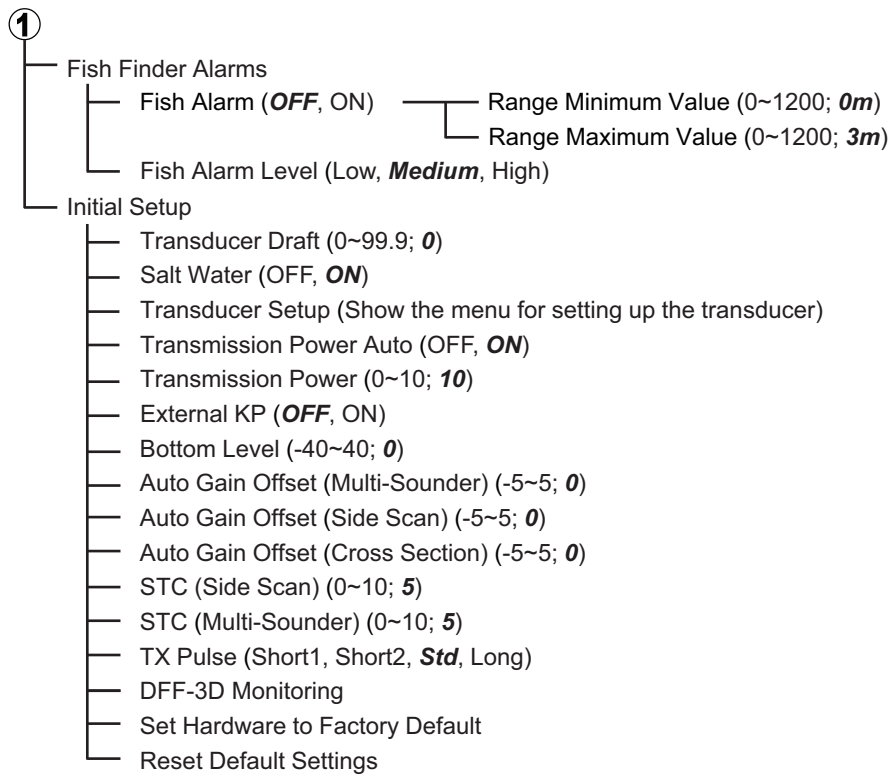

# APPENDIX 2 JIS CABLE GUIDE

Cables listed in the manual are usually shown as Japanese Industrial Standard (JIS). Use the following guide to locate an equivalent cable locally.

JIS cable names may have up to 6 alphabetical characters, followed by a dash and a numerical value (example: DPYC-2.5).

For core types D and T, the numerical designation indicates the *cross-sectional Area (mm<sup>2</sup>)* of the core wire(s) in the cable.

For core types M and TT, the numerical designation indicates the *number of core wires* in the cable.

## 1. Core Type

- D: Double core power line
- T: Triple core power line
- M: Multi core
- TT: Twisted pair communications (1Q=quad cable)

## 2. Insulation Type

- P: Ethylene Propylene Rubber

## 3. Sheath Type

- Y: PVC (Vinyl)

## 4. Armor Type

- C: Steel

## 5. Sheath Type

- Y: Anticorrosive vinyl sheath

## 6. Shielding Type

- S: All cores in one sheath
- S: Individually sheathed cores
- SLA: All cores in one shield, plastic tape w/aluminum tape
- SLA: Individually shielded cores, plastic tape w/aluminum tape



EX: <sup>1 2 3 4 5 6</sup> TTYCYSLA - 4  
 Designation type | # of twisted pairs

EX: <sup>1 2 3 4</sup> MPYC - 4  
 Designation type | # of cores

The following reference table lists gives the measurements of JIS cables commonly used with Furuno products:

Type	Area	Core Diameter	Cable Diameter	Type	Area	Core Diameter	Cable Diameter
DPYC-1.5	1.5mm <sup>2</sup>	1.56mm	11.7mm	TTYCS-1	0.75mm <sup>2</sup>	1.11mm	10.1mm
DPYC-2.5	2.5mm <sup>2</sup>	2.01mm	12.8mm	TTYCS-1T	0.75mm <sup>2</sup>	1.11mm	10.6mm
DPYC-4	4.0mm <sup>2</sup>	2.55mm	13.9mm	TTYCS-1Q	0.75mm <sup>2</sup>	1.11mm	11.3mm
DPYC-6	6.0mm <sup>2</sup>	3.12mm	15.2mm	TTYCS-4	0.75mm <sup>2</sup>	1.11mm	16.3mm
DPYC-10	10.0mm <sup>2</sup>	4.05mm	17.1mm	TTYCSLA-1	0.75mm <sup>2</sup>	1.11mm	9.4mm
DPYCY-1.5	1.5mm <sup>2</sup>	1.56mm	13.7mm	TTYCSLA-1T	0.75mm <sup>2</sup>	1.11mm	10.1mm
DPYCY-2.5	2.5mm <sup>2</sup>	2.01mm	14.8mm	TTYCSLA-1Q	0.75mm <sup>2</sup>	1.11mm	10.8mm
DPYCY-4	4.0mm <sup>2</sup>	2.55mm	15.9mm	TTYCSLA-4	0.75mm <sup>2</sup>	1.11mm	15.7mm
MPYC-2	1.0mm <sup>2</sup>	1.29mm	10.0mm	TTYCY-1	0.75mm <sup>2</sup>	1.11mm	11.0mm
MPYC-4	1.0mm <sup>2</sup>	1.29mm	11.2mm	TTYCY-1T	0.75mm <sup>2</sup>	1.11mm	11.7mm
MPYCSLA-4	1.0mm <sup>2</sup>	1.29mm	11.4mm	TTYCY-1Q	0.75mm <sup>2</sup>	1.11mm	12.6mm
MPYC-7	1.0mm <sup>2</sup>	1.29mm	13.2mm	TTYCY-4	0.75mm <sup>2</sup>	1.11mm	17.7mm
MPYC-12	1.0mm <sup>2</sup>	1.29mm	16.8mm	TTYCY-4S	0.75mm <sup>2</sup>	1.11mm	21.1mm
TPYC-1.5	1.5mm <sup>2</sup>	1.56mm	12.5mm	TTYCY-4SLA	0.75mm <sup>2</sup>	1.11mm	19.5mm
TPYC-2.5	2.5mm <sup>2</sup>	2.01mm	13.5mm	TTYCYS-1	0.75mm <sup>2</sup>	1.11mm	12.1mm
TPYC-4	4.0mm <sup>2</sup>	2.55mm	14.7mm	TTYCYS-4	0.75mm <sup>2</sup>	1.11mm	18.5mm
TPYCY-1.5	1.5mm <sup>2</sup>	1.56mm	14.5mm	TTYCYSLA-1	0.75mm <sup>2</sup>	1.11mm	11.2mm
TPYCY-2.5	2.5mm <sup>2</sup>	2.01mm	15.5mm	TTYCYSLA-4	0.75mm <sup>2</sup>	1.11mm	17.9mm
TPYCY-4	4.0mm <sup>2</sup>	2.55mm	16.9mm				

# APPENDIX 3 INSTALLATION OF TRANSDUCER B54, SS54

This appendix provides a copy of the installation instructions and Installation supplement for the AIRMAR® Technology Corporation Transducer B54, SS54. For the latest version of these instructions, see the materials provided with the transducer.

## INSTALLATION INSTRUCTIONS

### Depth Transducer *with Temperature Sensor & High-Performance Fairing*

Models: B54\_SS54

09/05/17

17-621-01-rev. 03

### WARNING

**Installation of the antirotation bolt is mandatory!**

**The anti-rotation bolt holds the fairing firmly in place. Failure to install the anti-rotation bolt may result in the fairing rotating while the boat is underway. The effect may be violent movement and loss of steering. This could result in serious injury or death to passengers and/or damage to the boat or other property.**

Follow the precautions below for optimal product performance and to reduce the risk of property damage, personal injury, and/or death.

**WARNING:** The transducer must be installed with a High-Performance Fairing.

**WARNING:** When installing the High-Performance Fairing carefully follow these installation instructions.

**WARNING:** Always wear safety glasses, a dust mask, and ear protection when installing.

**WARNING:** The fairing must be installed parallel to the keel to ensure proper boat handling.

**WARNING:** Do not install a fairing that has been mis-cut. Replace it.

- Cutting the fairing at an angle greater than the maximum allowed will cut into the transducer and/or bolt pocket, thus weakening the fairing.
- Do not allow any gap between the fairing and the hull that is greater than 3mm (1/8"). When the boat is underway, water will enter any gaps and push against the fairing with considerable force, possibly rotating it.

**WARNING:** Immediately check for leaks when the boat is placed in the water. Do not leave the boat unchecked for more than three hours. Even a small leak may allow considerable water to accumulate.

**CAUTION:** Bronze transducer —Never mount a bronze transducer in a metal hull, because electrolytic corrosion will occur.

**CAUTION:** Bronze transducer —Never install a bronze transducer on a vessel with a positive ground system.

**CAUTION: Stainless steel transducer in a metal hull—**Use sleeving to isolate the stainless steel transducer and anti-rotation bolt from the metal hull. Failure to do so will cause electrolytic corrosion.

**CAUTION:** Never pull, carry, or hold the transducer by the cable as this may sever internal connections.

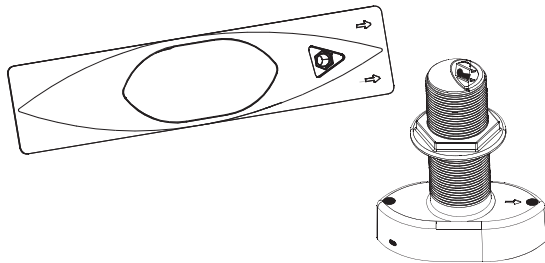

**CAUTION:** Never strike the transducer.

**CAUTION:** Do not over-tighten the hull nut and the nut on the anti-rotation bolt, crushing the fairing and/or hull.

**CAUTION:** The transducer and the yellow triangular plug must be flush with the fairing for smooth water flow under the transducer.

**CAUTION:** Never use solvents. Cleaner, fuel, sealant, paint, and other products may contain solvents that can damage plastic parts, especially the transducer's face.

**IMPORTANT:** Read the instructions completely before proceeding with the installation. These instructions supersede any other instructions in your instrument manual if they differ.

### Applications

- Bronze transducer recommended for fiberglass or wood hull.
- Stainless steel transducer compatible with all hull materials. Recommended for aluminum hulls to prevent electrolytic corrosion provided the stainless steel transducer is isolated from the metal hull.
- Maximum deadrise angle of 24°.

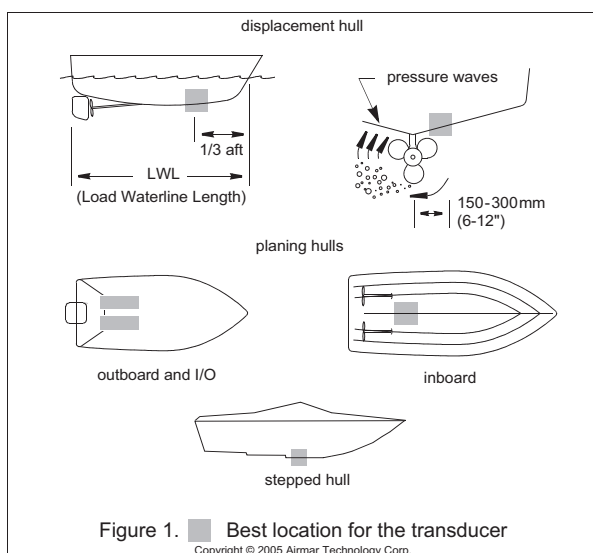

Figure 1. Best location for the transducer  
Copyright © 2005 Airmar Technology Corp.

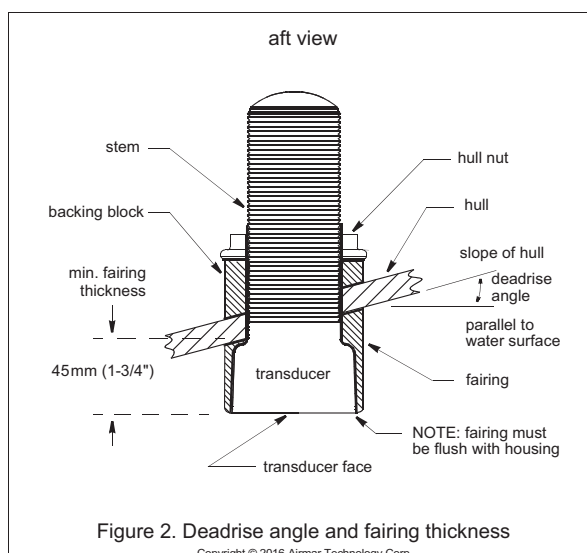

Figure 2. Deadrise angle and fairing thickness  
Copyright © 2016 Airmar Technology Corp.

### Identify Your Model

The model name is printed on the cable tag.

### Tools & Materials

Safety glasses

Dust mask

Ear protection

Electric drill

Drill bits and hole saws

Pilot hole 3mm or 1/8"

Model (Housing)	Hull Material	Transducer Hole-Saw Size	Anti-rotation Bolt Hole Drill Bit Size
B54 SS54	solid fiberglass wood	51 mm or 2"	11 mm or 7/16"
SS54	metal	57 mm or 2-1/4"	13 mm or 1/2"

Angle finder

Band saw (sharp blade)

Rasp or power tool

Sandpaper

Mild household detergent or weak solvent (such as alcohol)

File (installation in a metal hull)

Marine sealant (suitable for below waterline)

Slip-joint pliers

Mallet

Grommets (some installations)

Cable ties

Water-based anti-fouling paint (mandatory in salt water )

Installation in a cored fiberglass hull (see page 5)

Cylinders, wax, tape, and casting epoxy.

Model (Housing)	Hole Saw for Transducer (outer skin)	Minimum Size Hole Saw for Transducer (inner cored hull)	Drill Bit for Anti-rotation Bolt (outer skin)	Minimum Size Drill Bit for Anti-rotation Bolt (inner cored hull)
B54 SS54	51 mm or 2"	65 mm or 2-5/8"	11 mm or 7/16"	25 mm or 1"

2

### Mounting Location

**CAUTION:** Do not mount in line with or near water intake or discharge openings or behind strakes, struts, fittings, or hull irregularities that will disturb the water flow.

- The water flowing under the hull must be smooth with a minimum of bubbles and turbulence (especially at high speeds).
- The transducer's face must be continuously immersed in water.
- The transducer beam must be unobstructed by the keel or propeller shaft(s).
- Choose a location away from interference caused by power and radiation sources such as: the propeller(s) and shaft(s), other machinery, other echosounders, and other cables. The lower the noise level, the higher the echosounder gain setting that can be used.
- Choose a location with a minimum deadrise angle.
- Choose an accessible spot inside the vessel with adequate space for the height of the stem and tightening the nut.

### Boat Types (Figure 1)

- **Displacement hull powerboat**—Locate 1/3 of the way back along the LWL and 150–300mm (6–12") off the centerline. The starboard side of the hull where the propeller blades are moving downward is preferred.
  - **Planing hull powerboat**—Mount well aft near the centerline and well inboard of the first set of lifting strakes to insure that it is in contact with the water at high speeds. The starboard side of the hull where the propeller blades are moving downward is preferred.
  - **Outboard and I/O**—Mount just forward and to the side of the engine(s).
  - **Inboard**—Mount well ahead of the propeller(s) and shaft(s).
  - **Stepped hull** —Mount just ahead of the first step.
- Boat capable of speeds above 25kn (29MPH)—Review transducer location and operating results of similar boats before proceeding.

## APPENDIX 3 INSTALLATION OF TRANSDUCER B54, SS54

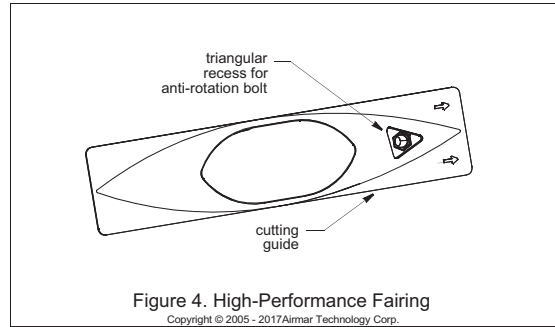
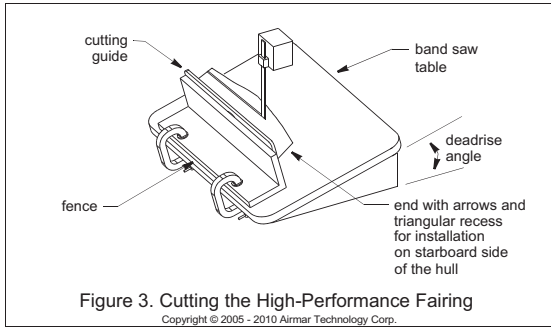

### Installation

Cored Fiberglass Hull —Follow separate instructions on page 5.

#### Hole Drilling: Transducer

1. Drill a 3mm or 1/8" pilot hole perpendicular to the waterline from inside the hull (Figure 2). If there is a rib, strut or other hull irregularity near the selected mounting location, drill from the outside.
2. Using the appropriate size drill bit or hole saw, cut a hole from outside the hull. Be sure to hold the drill plumb, so the hole will be perpendicular to the water surface.

#### Cutting the High-Performance Fairing

**CAUTION:** The end of the fairing with the arrows/triangular recess always points forward toward the bow when installed. Be sure to orient the fairing on the band saw, so the angle cut matches the intended side of the hull and not the mirror image.

1. Measure the deadrise angle of the hull at the selected mounting location using an angle finder (Figure 2). Check to be sure the angle does not exceed 24°.
2. Tilt the band saw table to the measured angle and secure the cutting fence (Figure 3). Do not exceed 24°.
3. Place the fairing on the table, so the cutting guide rests against the fence (Figure 4). The end with the arrows and triangular

recess will be pointing toward you for installation on the starboard side of the boat or away from you for installation on the port side.

4. Adjust the cutting fence, so the fairing will be cut in about two equal parts (Figure 3). The section that will become the fairing must be a minimum of 45mm (1-3/4") at its thinnest dimension (Figure 2).
5. Recheck steps 1 through 4. Then cut the fairing.
6. When the boat is underway, especially at high speeds, water will enter any gaps and push against the fairing with considerable force, possibly rotating it. Shape the fairing to the hull as precisely as possible with a rasp or power tool. If there is a gap of more than 3mm (1/8"), replace the fairing.
7. Check to be sure the transducer is flush with the fairing. If it is recessed more than 0.5mm (1/64") inside the fairing, you may shim the transducer or carefully file/sand the fairing.
8. The remaining section of the fairing with the cutting guide will be used as the backing block inside the hull. It will provide a level surface for tightening the nuts.

#### Hole Drilling: Anti-rotation Bolt

To locate and drill the hole for the anti-rotation bolt, use the fairing as a guide. This will ensure that the hole is perpendicular to the waterline and not drilled at the angle of the hull.

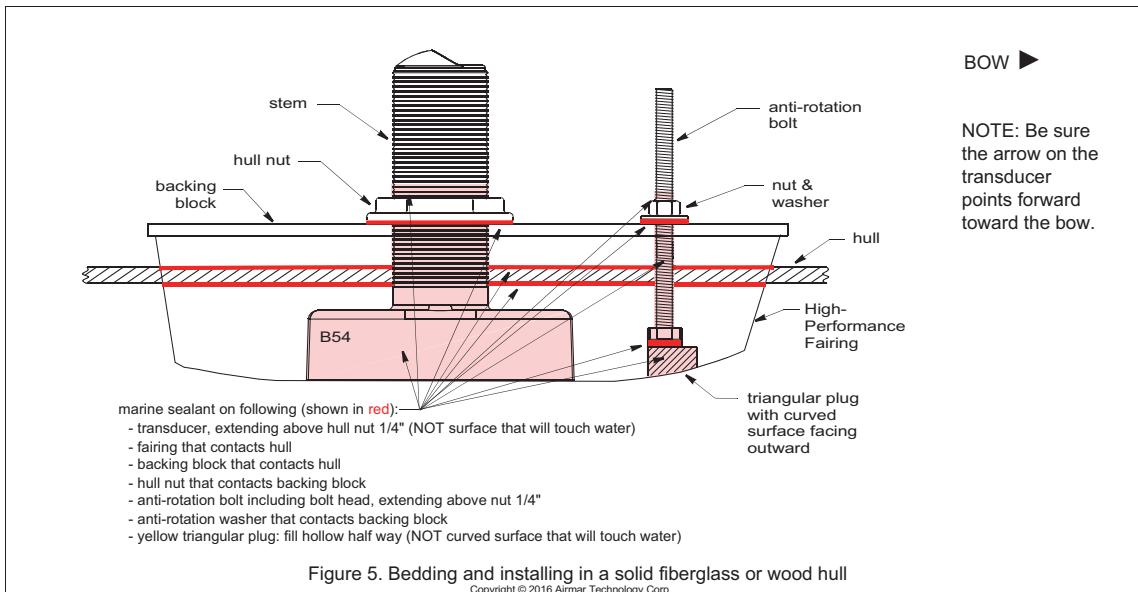

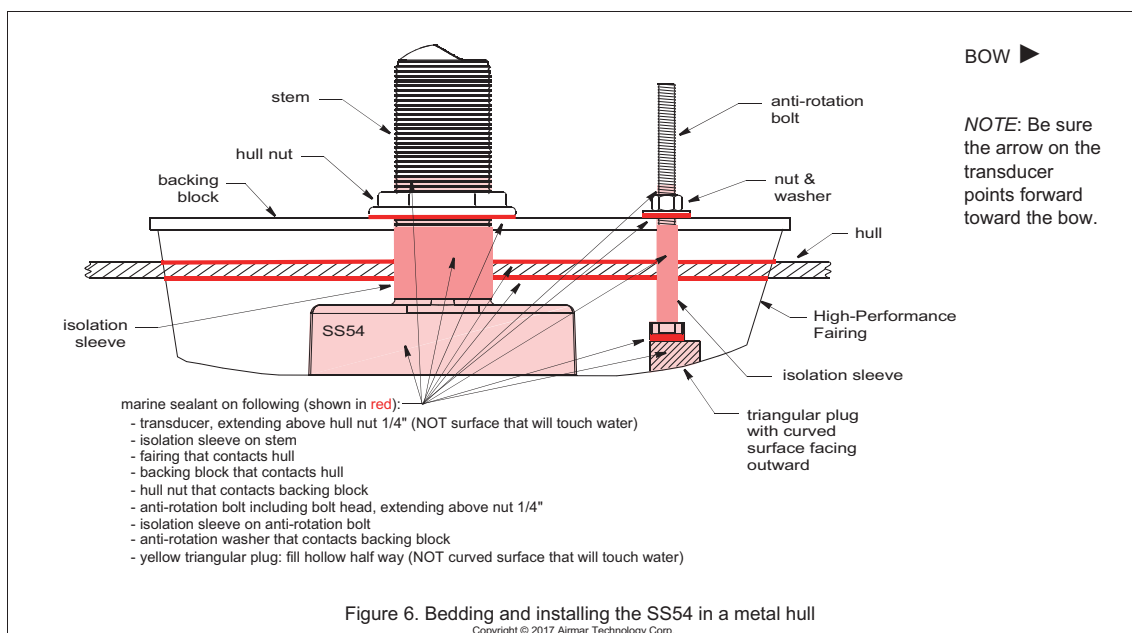

1. Dry fit the transducer in the fairing. Thread the cable through the large hole in the fairing and through the mounting hole in the hull. Seat the transducer firmly within the recess in the fairing (Figure 5 or 6). Be sure the arrow on the transducer points toward the triangular recess in the fairing.
2. Slide the transducer with the fairing in place into the mounting hole. Using the bolt hole in the fairing as your guide, drill a 3 mm (1/8") pilot hole through the hull for the anti-rotation bolt.
3. Using the appropriate size drill bit, hold the fairing in place and drill a hole for the anti-rotation bolt.
4. Remove the assembly and cable from the mounting hole.
5. Sand and clean the area around both holes, inside and outside, to ensure that the sealant will adhere properly to the hull. If there is any petroleum residue inside the hull, remove it with either mild household detergent or a weak solvent such as alcohol before sanding.

**Metal hull**—Remove all burrs with a file and sandpaper.

#### Bedding the Transducer

**CAUTION:** Be sure the surfaces to be bedded are clean and dry.

1. Remove the transducer from the fairing.
2. Apply a 2 mm (1/16") thick layer of marine sealant to the surface of the transducer that will contact the fairing and up the stem (Figure 5 or 6, areas in red). The sealant must extend 6 mm (1/4") higher than the combined thickness of the fairing, hull, backing block, and hull nut. This will ensure there is marine sealant in the threads to seal the hull and hold the hull nut securely in place.

Stainless steel transducer in a metal hull —To prevent electrolytic corrosion, the stainless steel housing must be isolated from the metal hull. Slide the isolation sleeve over the bedded transducer stem as far down as possible (Figure 6). Apply a 2 mm (1/16") thick layer of the marine sealant to the outside of the sleeve.

3. Apply a 2 mm (1/16") thick layer of marine sealant to the following surfaces:
  - Fairing that will contact the hull
  - Backing block that will contact the inside of the hull
  - Hull nut that will contact the backing block
4. Thread the transducer cable through the fairing and seat the transducer firmly within the recess. Be sure the arrow on the transducer points toward the triangular recess in the fairing.

#### Installing the Transducer

1. From outside the hull, thread the transducer cable through the mounting hole. Push the stem of the transducer (with the fairing in place) into the mounting hole using a twisting motion to squeeze out excess sealant (Figure 5 or 6). Be sure the arrow on the transducer points forward toward the bow.

**NOTE:** The transducer must be **FLUSH** with the fairing. If it is recessed more than 0.5 mm (1/64") inside the fairing, you may shim the transducer or carefully file/sand the fairing.

Stainless steel transducer in a metal hull —Be sure the isolation sleeve is between the transducer stem and the hull (Figure 6). However, the isolation sleeve must be below the washer and hull nut to prevent the sleeve from interfering with tightening the hull nut.

2. From inside the hull, slide the backing block onto the transducer cable and stem, seating the backing block firmly against the hull. Screw the hull nut in place, but do not tighten it at this time.

#### Bedding & Installing the Anti-rotation Bolt

**CAUTION:** Be sure the surfaces to be bedded are clean and dry.

1. Apply a 2 mm (1/16") thick layer of marine sealant to the anti-rotation bolt including the flange (Figure 5 or 6). The sealant must be 6 mm (1/4") higher than the combined thickness of the fairing, hull, backing block, washer, and nut. This will ensure that there is marine sealant on the threads to seal the hull and hold the nut securely in place.

**Stainless steel transducer in a metal hull**—To prevent electrolytic corrosion, the stainless steel anti-rotation bolt must be isolated from the metal hull. Slide the isolation sleeve over the bedded anti-rotation bolt as far down as possible (Figure 6). Apply a 2mm (1/16") thick layer of the marine sealant to the outside of the sleeve.

2. Apply a 2mm (1/16") thick layer of marine sealant to the side of the washer that will contact the backing block.
3. Push the anti-rotation bolt through the fairing and the hull.
4. From inside the hull, screw the washer (sealant side down) and the nut onto the anti-rotation bolt.

**Stainless steel transducer in a metal hull**—Be sure the isolation sleeve is between the anti-rotation bolt and the hull (Figure 6). However, the isolation sleeve must be below the washer and nut to prevent the sleeve from interfering with tightening the nut.

5. Use slip-joint pliers to tighten the hull nut. Then tighten the nut on the anti-rotation bolt. *Do not over-tighten, crushing the fairing or hull.*

**Cored fiberglass hull**—Do not over tighten, crushing the hull. **Wood hull**—Allow for the wood to swell before tightening the nut.

6. Use marine sealant to *half-fill* the hollow in the yellow triangular plug. Apply a 2mm (1/16") thick layer of marine sealant to the three sides of the plug that form the triangle. The sealant will hold the plug firmly within the fairing and fill any gap between the anti-rotation bolt and the plug.
7. *The yellow triangular plug fits one way only.* Push the yellow plug into the recess in the fairing until it is **FLUSH** with the outside of the fairing. This will squeeze out excess sealant. If necessary, tap it into place with a mallet.

**NOTE:** *If the triangular plug is slightly recessed within the fairing, use sealant to fill the gap. The plug must be **FLUSH** with the fairing for good performance.*

8. When the boat is underway, especially at high speeds, water will enter any gaps and push against the fairing with considerable force, possibly rotating it. Fill any gaps between the fairing and the hull with marine sealant. **If there is any gap greater than 3mm (1/8"), replace the fairing.** Remove the excess sealant on the outside of the fairing and hull to ensure smooth water flow under the transducer.

**Cable Routing & Connecting**

**CAUTION:** If the sensor came with a connector, do not remove it to ease cable routing. If the cable must be cut and spliced, use Airmar's splash-proof Junction Box No. 33-035 and follow the instructions supplied. Removing the waterproof connector or cutting the cable, except when using a water-tight junction box, will void the sensor warranty.

1. Route the cable to the instrument being careful not to tear the cable jacket when passing it through the bulkhead(s) and other parts of the boat. Use grommet(s) to prevent chafing. To reduce electrical interference, separate the transducer cable from other electrical wiring and the engine. Coil any excess cable and secure it in place with cable ties to prevent damage.
2. Refer to the instrument owner's manual to connect the transducer to the instrument.

**Checking for Leaks**

When the boat is placed in the water, **immediately** check around the transducer for leaks. Note that very small leaks may not be readily observed. Do not leave the boat in the water for more than 3 hours before checking it again. If there is a small leak, there may be considerable bilge water accumulation after 24 hours. If a leak is observed, repeat "Bedding" and "Installing" **immediately** (see page 4).

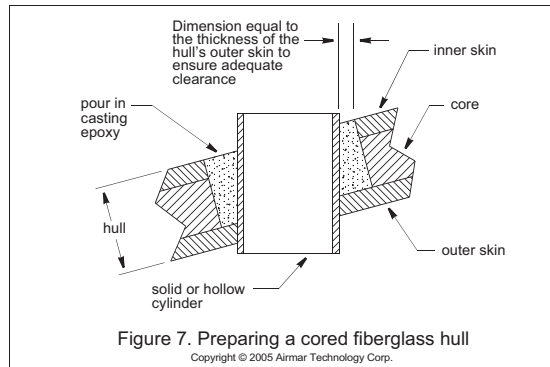

**Installation in a Cored Fiberglass Hull**

The core (wood or foam) must be cut and sealed carefully. The core must be protected from water seepage, and the hull must be reinforced to prevent it from crushing under the hull nut allowing the transducer to become loose.

**CAUTION:** Completely seal the hull to prevent water seeping into the core.

1. Drill a 3mm or 1/8" pilot hole perpendicular to the waterline from inside the hull (Figure 7). If there is a rib, strut, or other hull irregularity near the selected mounting location, drill from the outside. If the hole is drilled in the wrong location, drill a second hole in a better location. Apply masking tape to the outside of the hull over the incorrect hole and fill it with epoxy.
2. Using the appropriate size drill bit or hole saw, cut a hole from outside the hull through the outer skin only. *Be sure to hold the drill plumb, so the hole will be perpendicular to the water surface.*
3. The optimal interior hole diameter is affected by the hull's thickness and deadrise angle. It must be large enough in diameter to allow the core to be completely sealed.
  - Using the appropriate size drill bit or hole saw, cut through the inner skin and most of the core from inside the hull keeping the drill perpendicular to the hull. The core material can be very soft. Apply only light pressure to the hole saw after cutting through the inner skin to avoid accidentally cutting the outer skin.
4. Remove the plug of core material, so the inside of the outer skin and the inner core of the hull is fully exposed. Sand and clean the inner skin, core, and the outer skin around the hole.
5. Coat a hollow or solid cylinder of the correct diameter with wax and tape it in place. Fill the gap between the cylinder and hull with casting epoxy. After the epoxy has set, remove the cylinder.
6. Sand and clean the area around the hole, inside and outside, to ensure that the sealant will adhere properly to the hull. If there is any petroleum residue inside the hull, remove it with either mild household detergent or a weak solvent, such as alcohol, before sanding.
7. Follow the same procedure to prepare the hull for the anti-rotation bolt. Repeat steps 1 through 6.
8. Proceed with the installation beginning with "Cutting the Fairing" on page 3. Note that all holes are already drilled.

**Anti-fouling Paint**

Surfaces exposed to salt water must be coated with anti-fouling paint. Use **water-based** anti-fouling paint only. Never use ketone-based paint since ketones can attack many plastics possibly damaging the transducer. Reapply anti-fouling paint every 6 months or at the beginning of each boating season.



**Maintenance, Parts & Replacement***Cleaning*

Aquatic growth can accumulate rapidly on the transducer's face reducing its performance within weeks. Clean the surface with a Scotch-Brite® scour pad and mild household detergent taking care to avoid making scratches. If the fouling is severe, lightly wet sand with fine grade wet/dry paper.

*Replacement Transducer & Parts*

The information needed to order a replacement transducer is printed on the cable tag. Do not remove this tag. When ordering, specify the part number, date, and frequency in kHz. For convenient reference, record this information below.

Part No. \_\_\_\_\_ Date \_\_\_\_\_ Frequency \_\_\_\_\_ kHz

Lost, broken, and worn parts should be replaced immediately.

Hull nut, bronze	02-030
Hull nut, stainless steel	02-530-02
Fairing	04-883-01

Please contact your Furuno dealer to obtain parts.

# APPENDIX 4 INSTALLATION OF TRANSDUCER TM54

This appendix provides a copy of the installation instructions and Installation supplement for the AIRMAR® Technology Corporation Transducer TM54. For the latest version of these instructions, see the materials provided with the transducer.

## OWNER'S GUIDE &

Transom Mount, 1kW with Release Bracket

### Depth Transducer

with Temperature Sensor

Model TM54

08/21/17

17-299-04 rev. 02

**Follow the precautions below for optimal product performance and to reduce the risk of property damage, personal injury, and/or death.**

**WARNING:** Always wear safety goggles and a dust mask when installing.

**WARNING:** When the boat is placed in the water, immediately check for leaks around the screws and any other holes drilled in the hull.

**CAUTION:** Never pull, carry, or hold the transducer by the cables as this may sever internal connections.

**CAUTION:** Never strike the transducer to release it. When mounted on the bracket, remove the transducer by removing the locking pin and hinge pin.

**CAUTION:** Never use solvents. Cleaner, fuel, sealant, paint and other products may contain solvents that can damage plastic parts, especially the transducer's face.

**IMPORTANT:** Please read the instructions completely before proceeding with the installation. These instructions supersede any other instructions in your instrument manual if they differ.

### Tools & Materials

Safety goggles  
 Dust mask  
 Angle finder  
 Masking tape (some installations)  
 Pencil  
 Electric drill  
 Drill bits and hole saws:  
     Bracket holes                      5 mm, #4, or 7/32"  
     Transom hole (optional)        21 mm or 13/16"  
     Cable clamp holes                3 mm or 1/8"  
 Marine sealant (suitable for below waterline)  
 Socket wrench  
 Straight edge  
 Small screwdriver  
 Grommet(s) (some installations)  
 Cable ties  
 Water-based anti-fouling paint (mandatory in salt water )

## INSTALLATION INSTRUCTIONS

Record the information found on the cable tag for future reference.

Part No. \_\_\_\_\_ Date \_\_\_\_\_ Frequency \_\_\_\_\_ kHz

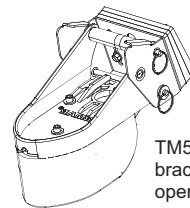

TM54 bracket with shims in operational position

### Applications

- Recommended for outboard and inboard/outboard sport fishing powerboats 8 m (25') and up
- Not recommended for inboard powerboats
- Not recommended for stepped hulls
- Adjusts to transom angles from 3°–21°
- Bracket protects transducer from frontal impact only

### Mounting Location

#### Guidelines

**CAUTION:** Do not mount the transducer in line with or near water intake or discharge openings or behind strakes, fittings, or hull irregularities that may disturb the water flow.

**CAUTION:** Avoid mounting the transducer where the boat may be supported during trailering, launching, hauling, or storage.

- For best performance, the transducer's face must be in contact with smooth water. To identify an area of "clean" water, observe the flow off the transom while the boat is underway.
- Allow space above the bracket for it to release and rotate the transducer upward.
- Mounting on the side of the transom where the propeller blades are moving downward is preferred (see Figure 1).
- Mount the transducer as far away from the propeller as possible while ensuring the transducer's face remains in the water when the boat is turning.

#### NOTES:

- To avoid noise interference, it is recommended that the propeller is located outside the transducer beam coverage of 120°.
- Starboard side of hull where propeller blades are moving downward is

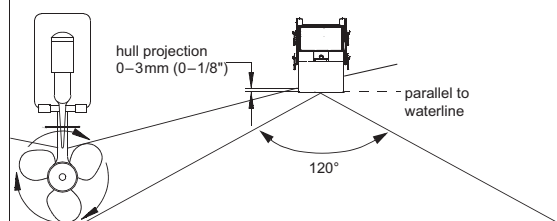

Figure 1. Mounting location on single drive boat

Copyright © 2009 - 2017 Airmar Technology Corp.

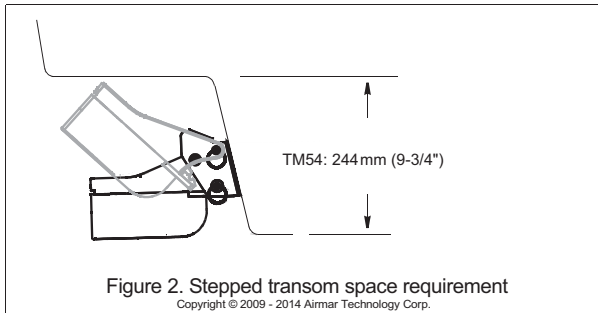

Figure 2. Stepped transom space requirement  
Copyright © 2009 - 2014 Airmar Technology Corp.

**Boat Types**

- Single drive —Mount a minimum of 15cm (6") beyond the swing radius of the propeller (see Figure 1).
- Twin drive —Mount between the drives a minimum of 15cm (6") beyond the swing radius of the propeller.
- Trim tabs —Mount inside the trim tab, space permitting.
- Stepped transom —Mount the transducer on the lowest step being sure there is enough space above the bracket for it to release and rotate the transducer upward (see Figure 2).

**Installation**

*Assembling the Transducer & Bracket*

1. There are two cables. Thread each cable through the corresponding hole in the transducer support (see Figure 3).
2. Fasten the support to the transducer using the three socket-head-cap screws and washers supplied. Tighten the screws with the 3/16" Allen wrench supplied.
3. Attach a safety ring to one end of each pin (see Figure 4).
4. While holding the transducer assembly against the bracket, insert a pin through the upper hole in the bracket and the support. Slide the spacer onto the pin and push it through the remaining hole in the support and the bracket. Attach a second safety ring. This pin will function as a hinge when the transducer is released.
5. Slide a washer onto the remaining pin. Push it through the lower hole in the bracket, slide it along the channel in the support, and through the second hole in the bracket. Slide the second washer onto the free end of the pin and attach the second safety ring. This will function as the locking pin to hold the transducer in the operational position when underway.

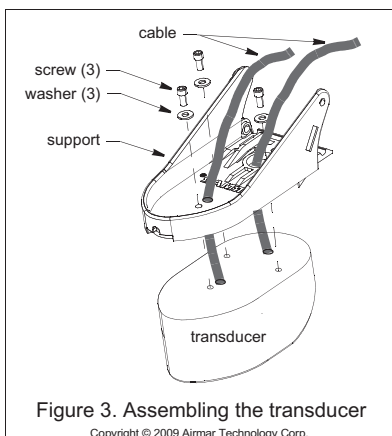

Figure 3. Assembling the transducer  
Copyright © 2009 Airmar Technology Corp.

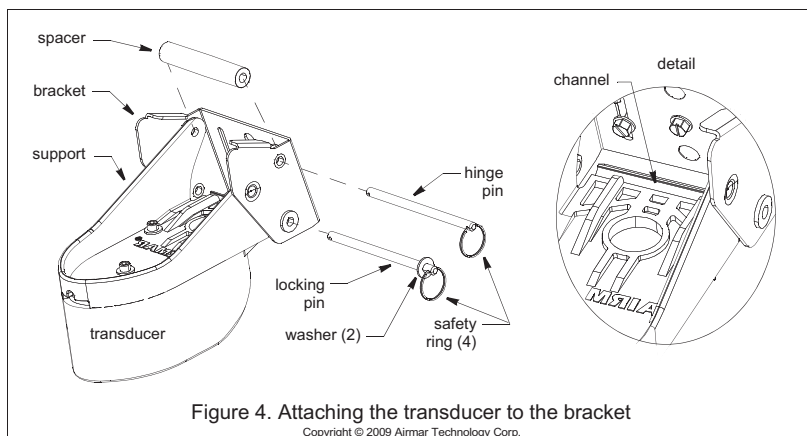

Figure 4. Attaching the transducer to the bracket  
Copyright © 2009 Airmar Technology Corp.

*Compensating for Transom Angle: Shims*

For the best performance, the transducer beam must be aimed straight at the bottom. Since the transom of most boats is angled, the bracket must compensate for it. Measure the transom angle of the boat with an angle finder.

- Standard transom (12° transom angle)—The bracket is designed for a standard 12° transom angle. No shim is needed for this installation. If your boat is capable of speeds above 20kn (28MPH), install the bracket with one 3° shim, taper down. This will ensure that the transducer is in contact with the water at high speeds.
- Using shims —The bracket is supplied with three shims; each one has a 3° angle. Up to three shims can be combined for a maximum of 9°. The shims are designed to mate together. Two bosses on the face fit into recesses in the back of another shim or the holes in the bracket.
  - Transom angles greater than 12° —Add the appropriate number of shims with the taper up to the 12° bracket angle.
  - Transom angles less than 12° —To reduce the bracket's 12° angle, group the appropriate number of shims with the taper down.
- If you are unsure about using the shim(s), experiment with them by following the instructions "Mounting & Adjusting the Bracket."

*Hole Drilling*

**CAUTION:** To prevent drilling too deeply, wrap masking tape around the bit 22mm (7/8") from the point.

**NOTE:** Fiberglass hull—Minimize surface cracking by running the drill in reverse until the gelcoat is penetrated.

1. At the selected mounting location, position the assembly so the transducer projects 3mm (1/8") below the bottom edge of the transom (see Figure 1). Be sure any shim(s) is in place. (You may want to tape the shim(s) to the bracket temporarily.) With the transducer in the operational position, mark the bottom corners of the bracket.
2. Remove the transducer assembly from the bracket by removing the locking pin and the hinge pin (see Figure 4). Hold the bracket with any shim(s) in place against the transom at the marked location. Draw an "X" at 12mm (1/2") from the top and the bottom of each slot (see Figure 6).
3. Using a 5mm, #4, or 7/32" drill bit, drill four holes 22mm (7/8") deep at the marked locations.

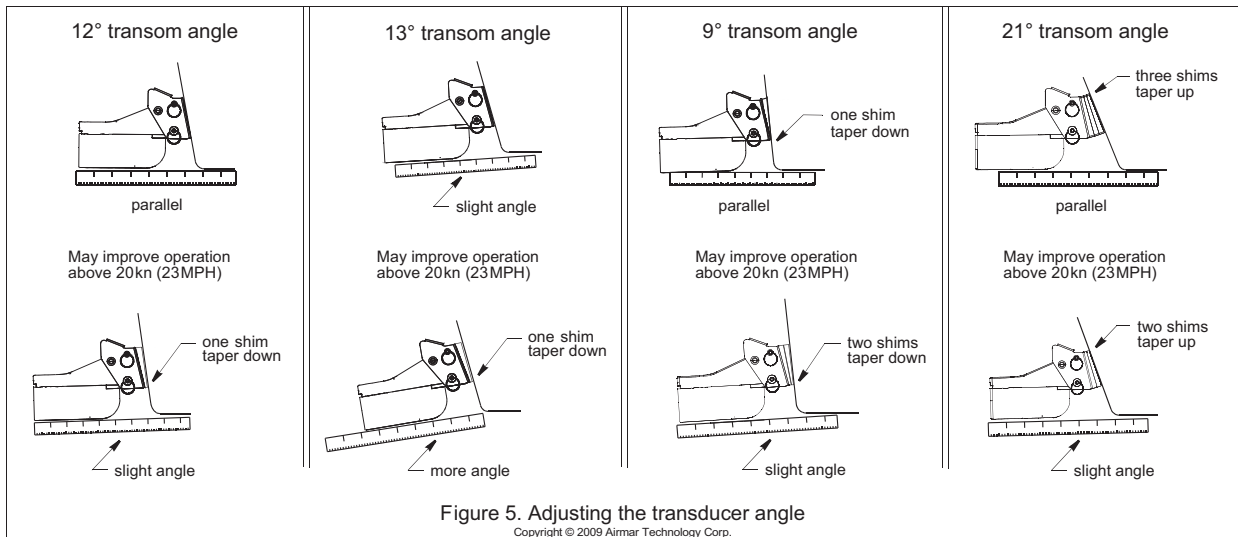

Figure 5. Adjusting the transducer angle

*Mounting & Adjusting the Bracket*

**CAUTION:** Do not position the leading edge of the transducer lower than the trailing edge because aeration will occur.

**CAUTION:** Do not position the transducer deeper in the water than necessary to avoid increasing drag, spray, and water noise and reducing boat speed.

**CAUTION:** The stainless steel bracket must be isolated from a metal hull to prevent electrolytic corrosion. If no shim is being used, place non-metal insulating washers between the bracket and the metal hull.

1. Apply marine sealant to the threads of four of the hex-washer-head screws to prevent water seepage into the transom. Being sure any shim(s) is in place, screw the bracket to the hull using a socket wrench (see Figure 4). Do not tighten the screws at this time.
2. Reinstall the transducer. While holding the transducer assembly against the bracket, insert the hinge pin through the upper hole in the bracket and the support. Slide the spacer onto the pin and push it through the remaining hole in the support and the bracket. Reattach the safety ring.
3. Slide a washer onto the locking pin. Push it through the lower hole in the bracket, slide it along the channel in the support, and through the second hole in the bracket. Slide the second washer onto the free end of the pin and reattach the safety ring.
4. With the transducer in the operational position, Use a straight edge to sight the underside of the transducer relative to the underside of the hull (see Figure 5). The trailing edge of the transducer should be 1–6mm (1/16–1/4") below the leading edge.

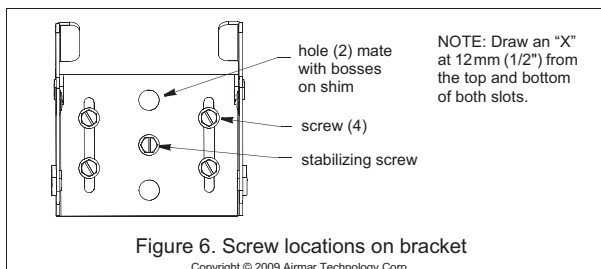

Figure 6. Screw locations on bracket

5. Using the vertical adjustment space in the bracket slots, slide the assembly up or down until the bottom inside corner of the transducer projections 0–3mm (0–1/8") below the bottom of the hull (see Figure 1). When you are satisfied with the position of the transducer, tighten the four bracket screws. For clear access to the screws, remove the transducer assembly from the bracket (see Figure 4). When reattaching, be sure to include the spacer.

**Testing on the Water**

1. Test the transducer at 165kHz with the engine off.
2. Become familiar with your echosounder's performance at a speed of 4kn (5 MPH).
3. Gradually increase the boat speed and observe the gradual decline of performance due to turbulent water flowing under the transducer's face.

**NOTE:** As the speed increases the performance at 50kHz will deteriorate more rapidly because more acoustic noise is generated at low frequencies.

4. If the decline in performance is sudden (not gradual), identify the boat speed at which the onset occurred. Return the boat to this speed, then gradually increase speed while making moderate turns in both directions.
5. If the performance improves while turning to the side on which the transducer is installed, it's position probably needs adjustment. The transducer is probably in turbulent or aerated water. To improve performance, try the following, one at a time, in the order given .
  - a. Increase the transducer's angle in the water. Review "Compensating for Transom Angle: Shims" and see Figure 5.
  - b. Move the transducer deeper into the water in increments of 3mm (1/8") (see Figure 1).
  - c. Move the transducer closer to the centerline of the boat. Fill unused screw holes with marine sealant.

6. Calibration —To match the speed shown on the display to the actual speed of the boat, you may need to calibrate the instrument. Refer to your instrument owner's manual.

**Stabilizing the Bracket**

1. Prevent the bracket from moving out of position using the remaining hex-washer-head screw. Drill the hole for the stabilizing screw through the center hole of the bracket, any shim(s), and the hull (see Figure 6).

2. Apply sealant to the threads of the remaining screw to prevent water seeping into the transom.
3. Fasten the stabilizing screw into place with a socket wrench. For clear access to the screw, remove the transducer assembly from the bracket (see Figure 4). When reattaching the transducer, be sure to include the spacer.

### Cable Routing & Connecting

**CAUTION:** Do not remove the connectors to ease cable routing. If the cables must be cut and spliced, use Airmar's splash-proof Junction Box No. 33-035 and follow the instructions provided. Removing the waterproof connectors or cutting the cables, except when using a water-tight junction box, will void the sensor warranty.

Route the cables over the transom for a detachable installation. For permanent mounting, route the cables through a drain hole or through new holes drilled in the transom above the waterline.

1. If holes must be drilled through the transom, choose a location well above the waterline (see Figure 7). Check for obstructions such as trim tabs, pumps, or wiring inside the hull. Mark the locations with a pencil. Drill each hole using a 21 mm or 13/16" bit to accommodate the connector.
2. Route the cables over or through the transom.
3. On the outside of the hull, secure each cable against the transom using the cable clamps supplied. For the first cable, position one cable clamp 30 cm (12") above the bracket. Mark the mounting hole with a pencil.
4. Position the second cable clamp halfway between the first clamp and the cable hole. Mark this mounting hole.
5. If a hole has been drilled through the transom, open the large slot in each transom cable cover. Position a cover over the cable where it enters the hull. Mark the two mounting holes.
6. For the second cable, repeat steps 3, 4, and 5.
7. At each of the marked locations, use a 3 mm or 1/8" bit to drill a hole 10 mm (3/8") deep.
8. Apply marine sealant to the threads of the #6 x 1/2" self-tapping screws to prevent water from seeping into the transom. If you have drilled holes through the transom, apply marine sealant to the space around the cables where they pass through the transom.
9. Position the four cable clamps and fasten them in place. If used, push a cable cover over each cable and screw them in place.
10. Route the cables to the instrument being careful not to tear the cable jackets when passing it through the bulkhead(s) and other parts of the boat. Use grommet(s) to prevent chafing. To reduce electrical interference, separate the transducer cables from other electrical wiring and the engine(s). Coil any excess cable and secure it in place with cable ties to prevent damage.
11. Refer to your echosounder owner's manual to connect the transducer to the instrument.

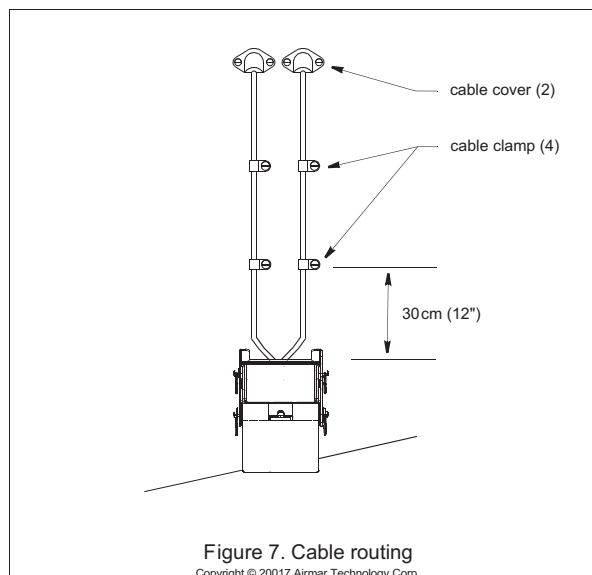

### Checking for Leaks

When the boat is placed in the water, immediately check for leaks around the screws and any other holes drilled in the hull. Note that very small leaks may not be readily observed. Do not leave the boat in the water unchecked for more than three hours.

### Maintenance

#### Anti-fouling Paint

**CAUTION:** Do not paint the exposed temperature button. Doing so will slow the sensor's response time.

Aquatic growth can accumulate rapidly on the transducer's face reducing performance within weeks. Surfaces exposed to salt water that do not interlock must be coated with anti-fouling paint. Use water-based anti-fouling paint only. Never use ketone-based paint, since ketones can attack many types of plastic possibly damaging the transducer. Repaint every 6 months or at the beginning of each boating season.

#### Cleaning

**CAUTION:** Do not use a lubricant on the bracket; grit will stick to it, increasing friction and wear.

Clean the sensor with a Scotch-Brite® scour pad and mild household detergent, taking care to avoid making scratches on the transducer's face. If the fouling is severe, lightly wet sand with fine grade wet/dry paper.

#### Transducer Replacement & Parts

The information needed to order a replacement transducer is printed on the cable tag. Do not remove this tag. When ordering, specify the part number, date, and frequency in kHz. For convenient reference, record this information on the top of page one.

Lost, broken, and worn parts should be replaced immediately.

Bracket Assembly

33-749-01

Please contact your Furuno dealer to obtain parts.

This page is intentionally left blank.

**SPECIFICATIONS OF MULTI BEAM SONAR  
DFF-3D**

**1 GENERAL**

- 1.1 TX frequency 165 kHz
- 1.2 Output power 800 W nominal
- 1.3 Amplifier type Straight amplifier (H/L gain sampling simultaneously)
- 1.4 Minimum range 3 m
- 1.5 Display mode Multi-sounder, Side scan, Section, 3D history
- 1.6 Depth range and Pulse repetition rate (PRR) (TX rate: 20, Pulse length: standard)

Range (m)	PRR (times/min, max.)
5	600
10	600
40	484
100	200
200	100
500	40
1200	37

**2 INTERFACE**

- 2.1 Number of port
  - LAN 1 port, Ethernet 10/100Base-TX
  - External KP 1 port (optional external KP kit required)

**3 POWER SUPPLY**

- 3.1 Multi beam sonar 12-24 VDC: 1.4-0.7 A
- 3.2 Rectifier (PR-62, option) 100/110/220/230 VAC, 1 phase, 50/60Hz

**4 ENVIRONMENTAL CONDITIONS**

- 4.1 Ambient temperature
  - Main unit -15°C to +55°C
  - Transducer -5°C to +35°C
- 4.2 Relative humidity 93% or less at +40°C
- 4.3 Degree of protection IP55
- 4.4 Vibration IEC 60945 Ed.4

**5 UNIT COLOR**

N2.5 (fixed)

# PACKING LIST

DFF-3D

026R-X-9851 -0 1/1

A-1

NAME	UNIT	OUTLINE	DESCRIPTION/CODE No.	QTY
ユニット マルチビームソナー			DFF-3D 000-029-991-00	1
<b>予備品</b>				
<b>SPARE PARTS</b>				
ガラス管 GLASS TUBE FUSE			FB80-A 125V 5A PBF 000-155-853-10	2
<b>工事材料</b>				
<b>INSTALLATION MATERIALS</b>				
ケーブル組品LAN LAN CABLE ASSEMBLY			MOD-2072-050+ 001-167-890-10	1
ケーブル組品MJ CABLE ASSEMBLY			MJ-ASPPF0013-035C(5A) 000-157-939-10	1
工事材料 INSTALLATION MATERIALS			CP02-09401 001-441-630-00	1
<b>図書</b>				
<b>DOCUMENT</b>				
取扱説明書 OPERATOR'S MANUAL			OM#-13520-* 000-191-428-1* **	1

コード番号末尾の[\*]\*\*は、選択品の代表コードを表します。  
CODE NUMBER ENDING WITH '\*\*\*' INDICATES THE CODE NUMBER OF REPRESENTATIVE MATERIAL.

(略図の寸法は、参考値です。 DIMENSIONS IN DRAWING FOR REFERENCE ONLY.)

KR

C1352-Z01-A

# FURUNO

A-2

CODE NO.	001-441-630-00		026R-X-9401 -1		
	TYPE	CP02-09401			
<b>工事材料表</b>					
<b>INSTALLATION MATERIALS</b>					
番号 NO.	名称 NAME	略図 OUTLINE	型名/規格 DESCRIPTIONS	数量 QTY	用途/備考 REMARKS
1	自己付ネジ SELF-TAPPING SCREW		SKZD-SUS304 CODE NO. 000-162-606-10	4	
2	圧着端子 CRIMP-ON LUG		FV1.25-4(LF) RED CODE NO. 000-166-666-10	1	
3	導電性テープ CONDUCTIVE TAPE		NO.1181 1"X181#50MM* CODE NO. 000-193-506-10	1	

(略図の寸法は、参考値です。 DIMENSIONS IN DRAWING FOR REFERENCE ONLY.)

FURUNO ELECTRIC CO., LTD.

KR

C1352-M01-B



表1 TABLE 1

寸法区分 (mm) DIMENSION	公差 (mm) TOLERANCE
0 < L ≤ 50	±1.5
50 < L ≤ 100	±2.5
100 < L ≤ 500	±3

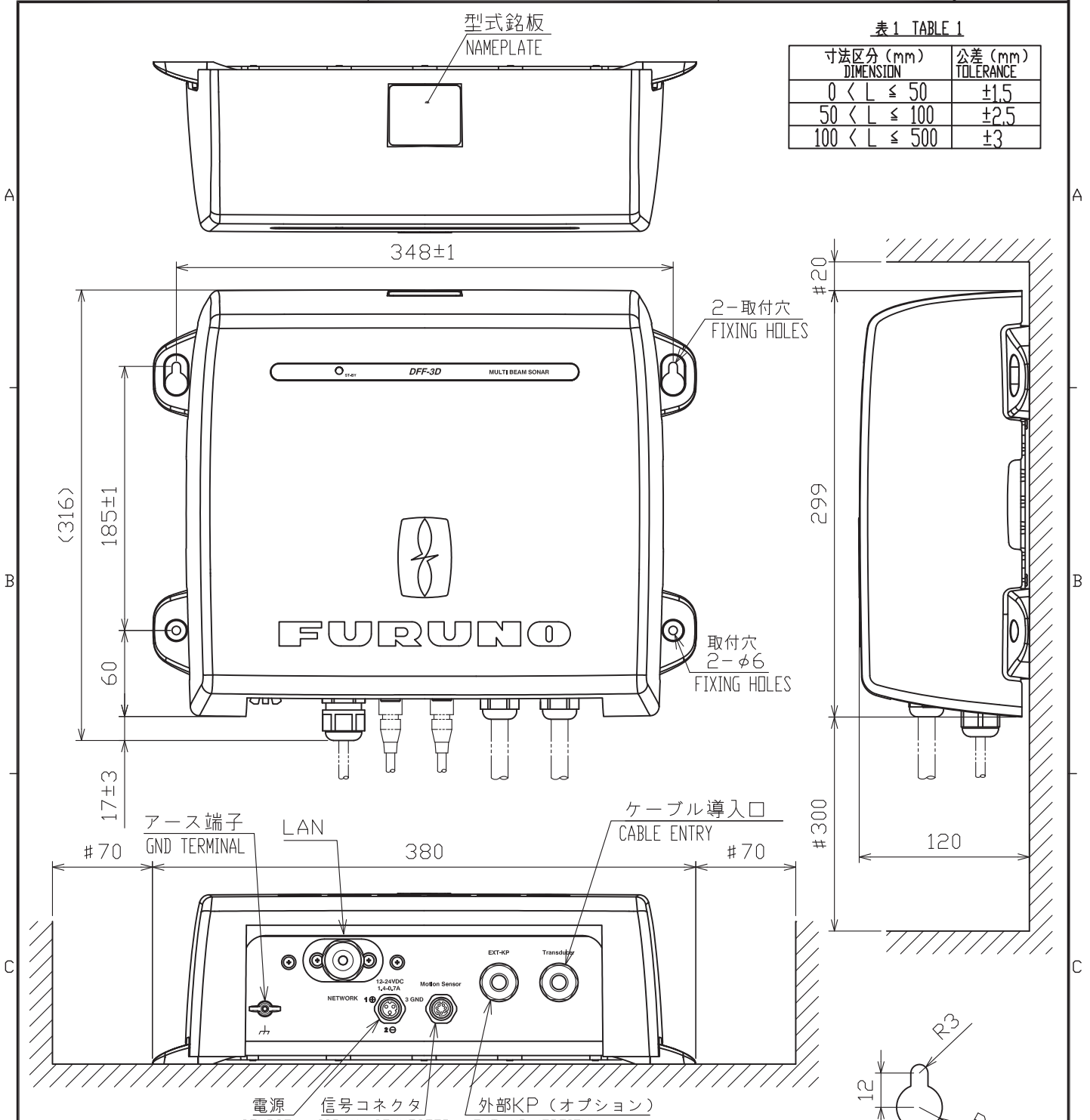

- 注記
- 1) 指定外の寸法公差は表1による。
  - 2) #印寸法は最小サービス空間寸法とする。
  - 3) 取付用ネジはトラスタッピングネジ呼び径5×20を使用のこと。
  - 4) 壁掛時、ケーブルは下方のみとする。

- NOTE
1. TABLE 1 INDICATES TOLERANCE OF DIMENSIONS.
  2. #: MINIMUM SERVICE CLEARANCE.
  3. USE TAPPING SCREWS  $\phi 5 \times 20$  FOR FIXING THE UNIT.
  4. FACE THE CABLES DOWNWARD FOR BULKHEAD MOUNTING.

取付穴詳細 (尺度: 1/2)  
DETAIL FOR FIXING (SCALE: 1/2)

DRAWN	16/Sep/2016	T.YAMASAKI	TITLE	DFF-3D
CHECKED	16/Sep/2016	H.MAKI	名称	マルチビームソナー
APPROVED	20/Sep/2016 H.MAKI			外寸図
SCALE	1/4	MASS 3.0 ±10% kg	NAME	MULTI BEAM SONAR
DWG.No.	C1352-G01- B		REF.No.	02-173-100G-3
				OUTLINE DRAWING

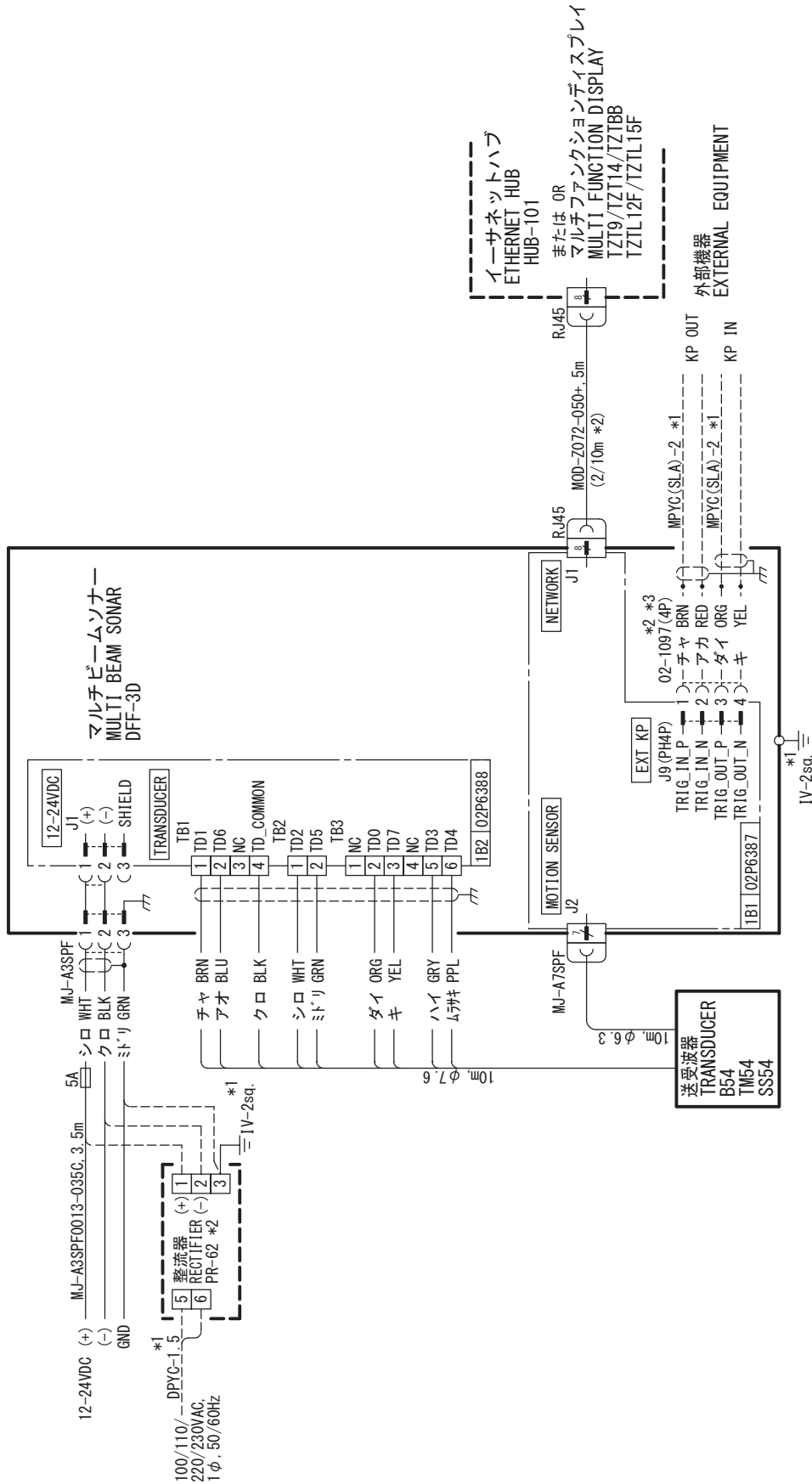

注記

- \*1) 造船所手配。
  - \*2) オプション。
  - \*3) KPキット (OP02-86) が必要。
- NOTE
- \*1: SHIPYARD SUPPLY.
  - \*2: OPTION.
  - \*3: KP KIT (OP02-86) REQUIRED.

DRAWN	20/Mar/2018	T. YAMASAKI	TITLE	DFF-3D
CHECKED	20/Mar/2018	H. MAKI	名称	マルチビームソナー
APPROVED	27/Mar/2018	H. MAKI		相互結線図
SCALE	MASS	kg	NAME	MULTI BEAM SONAR
DWG. No.	C1352-C01-F		REF. No.	02-173-1401-0
INTERCONNECTION DIAGRAM				

# INDEX

## **Numerics**

3D sounder history display	
echo detection level .....	4-12
example .....	4-3
function availability .....	4-17
marking school of fish .....	4-11
noise filter .....	4-12
picture advancement .....	4-12
scale box .....	4-16
terrain shading .....	4-13
TX and ST-BY .....	4-11
viewpoint position .....	4-11

## **B**

Beam angle (multi-sounder display).....	4-4
Beam type selection (multi-sounder display).....	4-4
Beam width (multi-sounder display) .....	4-4
Bottom echo calibration.....	4-12

## **C**

Cross section display	
example .....	4-3
function availability .....	4-10
grid .....	4-8
scale box .....	4-9
speed of sound correction .....	4-9
TX and ST-BY .....	4-8

## **D**

Default settings .....	5-2
Depth/color shading .....	4-13
DIP switch settings .....	3-1

## **E**

Echo color (side scan display) .....	4-6
Echo detection level .....	4-12
Echo smoothing	
distance .....	4-8
time .....	4-9
External KP cable installation.....	2-5

## **F**

Function availability	
3D sounder history display .....	4-17
cross section display .....	4-10
multi-sounder display .....	4-5
side scan display .....	4-7
Fuse replacement .....	5-2

## **G**

Grid (cross section display).....	4-8
-----------------------------------	-----

## **I**

Installation .....	1-2
DIP switch settings .....	3-1
external KP cable .....	2-5

ground .....	2-1
LAN cable.....	2-9
multi beam sonar.....	1-2
multi function display settings.....	3-4
operation check.....	3-3
transducer .....	1-3, AP-4, AP-10
transducer cable.....	2-2
wiring.....	2-1

## **J**

JIS cable guide.....	AP-3
----------------------	------

## **L**

LAN cable installation.....	2-9
-----------------------------	-----

## **M**

Maintenance.....	5-1
Menu tree .....	AP-1
Multi-sounder display	
beam angle .....	4-4
beam type selection .....	4-4
beam width .....	4-4
example.....	4-1
function availability .....	4-5
scale box .....	4-4
TX and ST-BY .....	4-4

## **N**

Noise filter .....	4-12
--------------------	------

## **S**

Scale box	
3D sounder history display .....	4-16
cross section display .....	4-9
multi-sounder display .....	4-4
side scan display .....	4-6
Side scan display	
echo color.....	4-6
example.....	4-2
function availability .....	4-7
scale box .....	4-6
TX and ST-BY .....	4-6

## **T**

Terrain shading .....	4-13
Transducer cable installation .....	2-2
Transducer installation .....	1-3, AP-4, AP-10
TX and ST-BY	
3D sounder history display .....	4-11
cross section display .....	4-8
multi-sounder display .....	4-4
side scan display .....	4-6

## **V**

Viewpoint position (3D sounder history display) .....	4-11
---	------

INDEX

**Z**

Zoom display.....4-8

## EC Declaration of Conformity



We **FURUNO ELECTRIC CO., LTD.**

(Manufacturer)

9-52 Ashihara-Cho, Nishinomiya City, 662-8580, Hyogo, Japan

(Address)

declare under our sole responsibility that the product

**MULTI BEAM SONAR DFF-3D**

(Model name, type number)

to which this declaration relates is in conformity with the following standard(s) or other normative document(s)

IEC 60945 Ed.4.0: 2002 incl. Corr. 1: 2008

(title and/or number and date of issue of the standard(s) or other normative document(s))

For assessment, see

- Test Report LIC 12-15-164, LIC 12-15-165 and LIC 12-15-166, February 16, 2016 prepared by Labotech International Co., Ltd.

This declaration is issued according to the Directive 2014/30/EU of the European Parliament and of the Council of 26 February 2014 on the harmonisation of the laws of the Member States relating to electromagnetic compatibility.

On behalf of Furuno Electric Co., Ltd.

Yoshitaka Shogaki  
Department General Manager  
Quality Assurance Department

Nishinomiya City, Japan  
April 20, 2016

(Place and date of issue)

(name and signature or equivalent marking of authorized person)