

# Transom Mount Chirp Transducers

Unlock the true potential of your fishfinder with the superior quality and performance of an AIRMAR Chirp-ready transducer.

*TM275LHW screenshot courtesy of Raymarine*

## The Benefits of AIRMAR's Chirp-ready Transducers

- One broadband transducer covers up to 117 kHz of bandwidth – greater opportunities to detect fish in the water column
- Superior resolution – precise separation between baitfish and gamefish represented on the display with crisp images
- Enhanced bottom fishing – resolve targets close to the bottom or near structure/wrecks
- Amazing detail – recognize haloclines and thermoclines
- Improved signal to noise ratio – find fish and track bottom at high boat speeds



## Benefits of Transom Mount Transducers

Transom models are best suited for small and trailered vessels where a thru-hull installation is not practical. Perfect for freshwater boat styles and center consoles. Simple to install and ideal for small trailered vessels where a thru-hull may interfere with loading.

- Simple installation on transom of the boat
- Great performance at boat speeds below 30 knots
- Easy maintenance and low-cost replacement

# Why does frequency matter?

Selecting the best frequency for your specific application is very important. The good news is that once you know what frequency will work best for the type of fishing you do, there's an AIRMAR transducer designed to maximize the performance of your sounder.

AIRMAR Chirp transducers are available in various frequency combinations:

- Dual Band:
  - Low/High (LH)
  - Low/Medium (LM)
  - Low/High Wide (LHW)
  - Low Wide/Medium (LWM)
- Single Band:
  - Low
  - Medium
  - High
  - High Wide

## Low Frequency = Greater Depth (ex. 42-65 kHz)

- Sound waves will not present as clear a picture of the bottom on the display, but will sound down in very deep areas where high frequency sound waves cannot reach
- Provides greater depth range, wider beamwidth, and ultimately more coverage under the boat
- Chirp signal processing technology used with AIRMAR broadband, Chirp-ready transducers provides more detail at greater depths and is less susceptible to noise
- Great for operating at high boat speeds

## High Frequency = Greater Detail (ex. 130-210 kHz)

- More sensitive to small targets and will send back detailed information which will display as crisp, high-resolution images on the echosounder screen
- Best for shallower water and popular with anglers fishing at depths less than 1500 feet

## Medium Frequency = The Best of Both Worlds (ex. 80-130 kHz)

- Provides the ability to sound deeper than the high frequency, along with better resolution than the low frequency
- Wider beam than the high frequency, achieving more coverage under the boat and greater opportunity to find fish
- Clear images at higher boat speeds

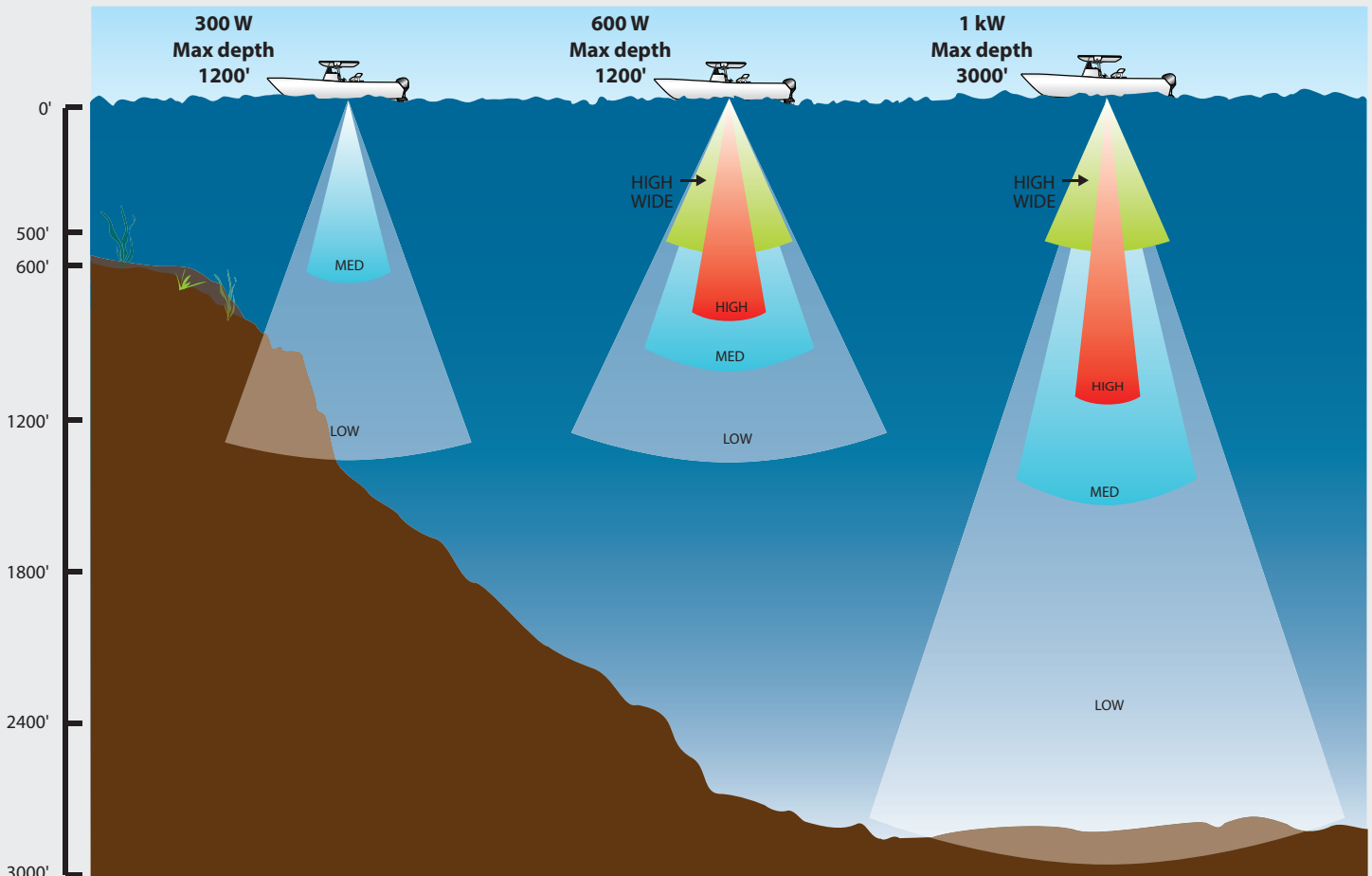

# Transom Mount 300 W & 600 W



## Features:

- Depth & fast-response water-temperature sensor
- Hull Type: For displacement or planing hulls (wood, fiberglass, aluminum or steel)
- Engine Type: Single or twin I/O, OB and jet drive systems

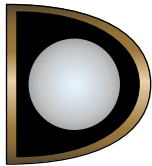

1-Internal  
Broadband Ceramic  
Assembly

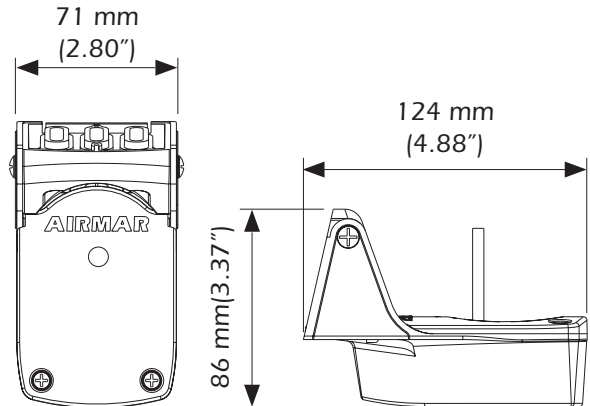

## TM150M

300 W

### Medium Frequency

- Medium—95 kHz to 155 kHz  
26° to 17° beamwidth  
Maximum depth 600 ft
- 60 kHz of total bandwidth from one transducer

\* This model is a 300 W.

WIDE  
BEAM

## TM165HW

600 W

### High Wide Frequency

- High—150 kHz to 250 kHz  
30° average beamwidth  
Maximum depth 500 ft
- 100 kHz of total bandwidth from one transducer

\* This model is a 600 W.

## Bottom Coverage Relative to Frequency and Depth

Depth	Beam Coverage at Different Frequencies	
	TM150M 95 kHz-155 kHz	TM165HW 150 kHz-250 kHz
50 ft	24 ft	26 ft
100 ft	46 ft	54 ft
300 ft	138 ft	160 ft
600 ft	278 ft	Too Deep
1000 ft	Too Deep	Too Deep

This chart compares the high wide and medium ceramic elements inside the transducer, showing the difference in bottom coverage under the boat.

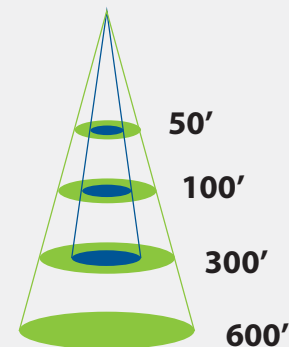

TM150M – Medium Frequency  
95 kHz-155 kHz  
TM165HW – High Frequency  
150 kHz-250 kHz

# Transom Mount 1 kW



## Features:

- Depth & fast-response water-temperature sensor
- Hull Type: For displacement or planing hulls (wood, fiberglass, aluminum or steel)
- Engine Type: Single or twin I/O, OB and jet drive systems

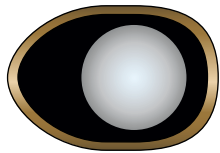

1-Internal  
Broadband Ceramic  
Assembly

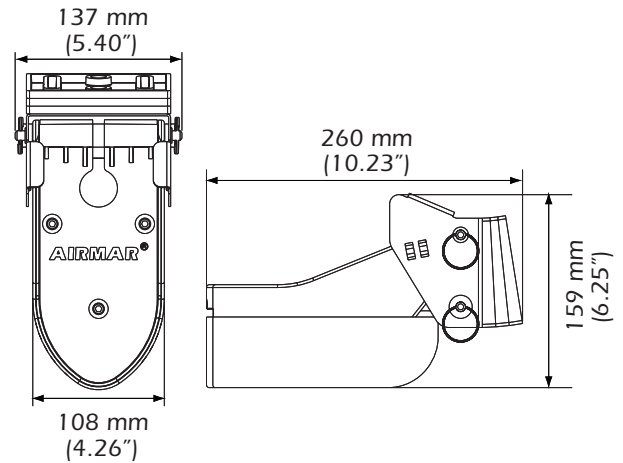

## TM185M

### Medium Frequency

- Medium—85 kHz to 135 kHz  
16° to 11° beamwidth  
Maximum depth 1500 ft
- 50 kHz of total bandwidth from one transducer

WIDE  
BEAM

## TM185HW

### High Wide Frequency

- High—150 kHz to 250 kHz  
25° constant beamwidth  
Maximum depth 500 ft
- 100 kHz of total bandwidth from one transducer

## Bottom Coverage Relative to Frequency and Depth

Depth	Beam Coverage at Different Frequencies	
	TM185M 85 kHz-135 kHz	TM185HW 150 kHz-250 kHz
50 ft	14 ft	22 ft
100 ft	28 ft	44 ft
300 ft	84 ft	134 ft
600 ft	168 ft	266 ft
1000 ft	282 ft	Too Deep
1500 ft	422 ft	Too Deep

This chart compares the high wide and medium ceramic elements inside the transducer, showing the difference in bottom coverage under the boat.

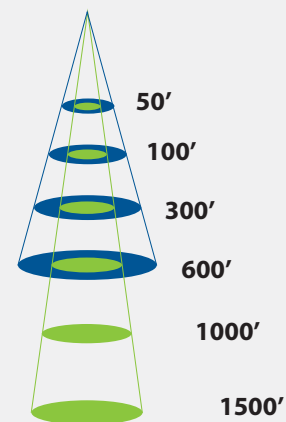

TM185M – Medium Frequency  
85 kHz-135 kHz  
TM185HW – High Frequency  
150 kHz-250 kHz

# Transom Mount 1 kW



## Features:

- Depth & fast-response water-temperature sensor
- Hull Type: For displacement or planing hulls (wood, fiberglass, aluminum or steel)
- Engine Type: Single or twin I/O, OB and jet drive systems

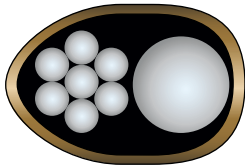

8-Internal  
Broadband Ceramic  
Assemblies

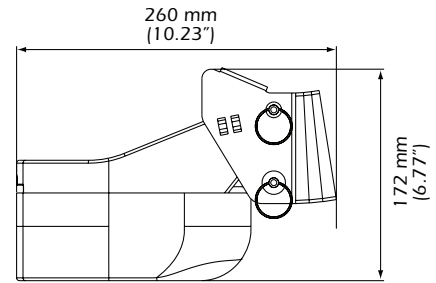
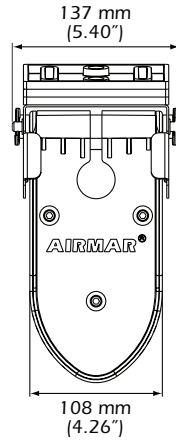

## TM265LH

### Low & High Frequency

- Low—42 kHz to 65 kHz  
25° to 16° beamwidth  
Maximum depth 3000 ft
- High—130 kHz to 210 kHz  
10° to 6° beamwidth  
Maximum depth 1000 ft
- 103 kHz of total bandwidth from one transducer

## TM265LM

### Low & Medium Frequency

- Low—42 kHz to 65 kHz  
25° to 16° beamwidth  
Maximum depth 3000 ft
- Medium—85 kHz to 135 kHz  
16° to 11° beamwidth  
Maximum depth 1500 ft
- 73 kHz of total bandwidth from one transducer

WIDE  
BEAM

## TM275LHW

### Low & High Wide Frequency

- Low—42 kHz to 65 kHz  
25° to 16° beamwidth  
Maximum depth 3000 ft
- High—150 kHz to 250 kHz  
25° constant beamwidth  
Maximum depth 500 ft
- 123 kHz of total bandwidth from one transducer

## Bottom Coverage Relative to Frequency and Depth

Depth	Beam Coverage at High Frequency		
	TM265LH 130 kHz-210 kHz	TM265LM 85 kHz-135 kHz	TM275LHW 150 kHz-250 kHz
50 ft	10 ft	14 ft	22 ft
100 ft	20 ft	28 ft	44 ft
300 ft	58 ft	84 ft	134 ft
600 ft	104 ft	168 ft	266 ft
1000 ft	174 ft	282 ft	Too Deep
2000 ft	Too Deep	422 ft	Too Deep

This chart compares the high and medium ceramic elements inside the transducer, showing the difference in bottom coverage under the boat.

Low frequency in each of these transducer models is the same (42 kHz - 65 kHz).  
The maximum depth range sounds to 3,000 ft.

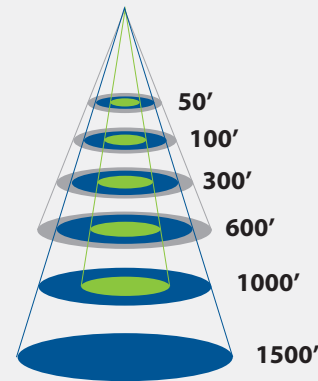

- TM265LH – High Frequency  
130 kHz-210 kHz
- TM265LM – Medium Frequency  
85 kHz-135 kHz
- TM275LHW – Wide beam Frequency  
150 kHz-250 kHz

## The Chirp Advantage

Traditional sounders operate at only two discrete frequencies – typically 50 kHz and 200 kHz. This results in limited depth range, resolution, and ultimately what targets can be detected in the water column.

In contrast, AIRMAR's game-changing Chirp-ready transducers provide over 70+ kHz of bandwidth. Transmitting over a wide frequency band results in a greater opportunity to detect what is in the water column. As a result, all targets detected in the entire bandwidth will be seen on the display—even those fish holding close to the bottom—ultimately improving target detection, detail, and range resolution.

Most Chirp transducers vary their beam width as they sweep through their frequency range (low, medium, and high). At the lowest frequency the beam is the widest and it narrows as the frequency increases.

AIRMAR's new wide beam Chirp transducers are the exception to this rule and have a fixed beam width of either 25° or 40° across the frequency band. This translates into even more coverage under the boat, revealing more fish in the water column than ever before.

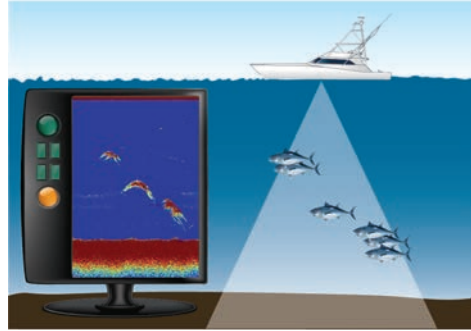
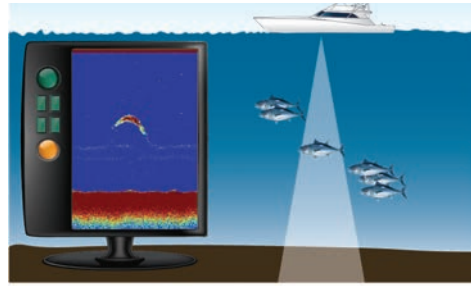

The fish must be in the beam to be represented on the display.

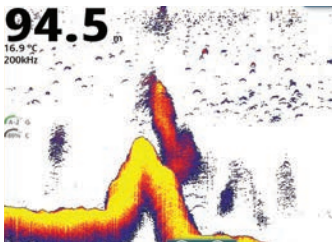

Courtesy of Navico

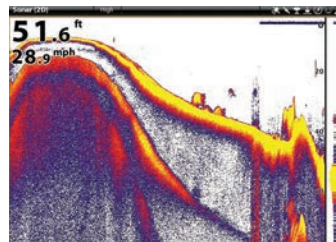

Courtesy of Humminbird

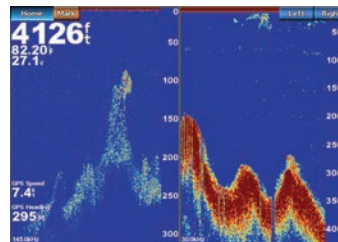

Courtesy of Garmin

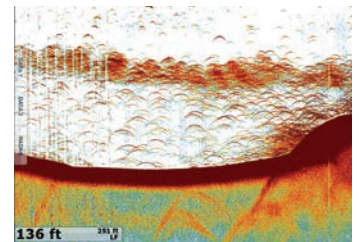

Courtesy of Furuno

## Additional Mounting Options

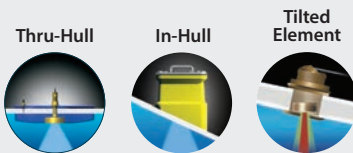

Choosing your mounting option depends on the design of the hull as well as the material it's manufactured with, the boats intended use, and the desired level of performance.

## Need Help Choosing the Right Transducer?

Download the free, award-winning **iNstall app**! It's a great tool that takes the guesswork out of selecting the right transducer for your application. Based on frequency, mounting, housing, and cable options, iNstall will reveal the available option(s) and give you instant access to their specifications. Designed for iPhone, iPad and iPod smart phones and tablets running iOS 6.1 and newer.



iNstall



[www.airmar.com](http://www.airmar.com)

©Airmar Technology Corporation

TransomMountChirp\_BR\_re 10/04/19

As Airmar constantly improves its products, all specifications are subject to change without notice. All Airmar products are designed to provide high levels of accuracy and reliability, however they should only be used as aids to navigation and not as a replacement for traditional navigation aids and techniques. Xducer ID is a registered trademark of Airmar Technology Corporation. Other company or product names mentioned in this document may be trademarks or registered trademarks of their respective companies, which are not affiliated with Airmar.